

Esprit

- by - 



ET8 / ET6
Motorized Treadmill



ET10
Motorized Treadmill

OWNER'S MANUAL

**PLEASE CAREFULLY READ THIS ENTIRE MANUAL BEFORE
OPERATING YOUR NEW TREADMILL!**

Table of Contents

Product Registration.....	2
Important Safety Instructions.....	3
Important Electrical Information.....	4
Important Operation Instructions.....	5
Assembly instructions.....	6
Folding & Transport Instructions.....	12
Operation of Your New Treadmill.....	13
Programmable Features.....	16
Target Heart Rate.....	18
Using a Heart Rate Transmitter.....	19
Heart Rate Control Operation.....	20
General Maintenance.....	21
Service Checklist - Diagnosis Guide.....	24
Manufacturer's Limited Warranty.....	26

SPIRIT

**CONGRATULATIONS ON YOUR
NEW TREADMILL AND WELCOME
TO THE SPIRIT FAMILY!**

Thank you for your purchase of this quality treadmill from Spirit Manufacturing, Inc. Your new treadmill was manufactured by one of the leading fitness manufacturers in the world and is backed by one of the most comprehensive warranties available. Through your dealer, Spirit will do all we can to make your ownership experience as pleasant as possible for many years to come. The local dealership where you purchased this treadmill is your administrator for all Spirit warranty and service needs. Their responsibility is to provide you with the technical knowledge and service personnel to make your experience more informed and any difficulties easier to remedy.

Please take a moment at this time to record the name of the dealer, their telephone number, and the date of purchase below to make any future, needed contact easy. We appreciate your support and we will always remember that you are the reason that we are in business. Please complete and mail your registration card today and enjoy your new treadmill.

Yours in Health,
Spirit Manufacturing, Inc.

Name of Dealer _____
Telephone Number of Dealer _____
Purchase Date _____

Product Registration

RECORD YOUR SERIAL NUMBER

Please record the Serial Number of this fitness product in the space provided below.

Serial Number _____

REGISTER YOUR PURCHASE

The self-addressed product registration card must be completed in full and returned to Spirit Manufacturing, Inc. or visit www.spiritfitness.com/warranty.htm to register online.

ET6 / ET8 / ET10 Ver. A

Important Safety Instructions

WARNING - Read all instructions before using this appliance.

DANGER - To reduce the risk of electric shock disconnect your Spirit treadmill from the electrical outlet prior to cleaning and/or service work.

WARNING - To reduce the risk of burns, fire, electric shock, or injury to persons, install the treadmill on a flat level surface with access to a 120-volt, 20-amp grounded outlet.

DO NOT USE AN EXTENSION CORD UNLESS IT IS 14AWG OR BETTER, WITH ONLY ONE OUTLET ON THE END. The treadmill should be the only appliance in the circuit in which it is connected. **DO NOT ATTEMPT TO DISABLE THE GROUNDED PLUG BY USING IMPROPER ADAPTERS, OR IN ANY WAY MODIFY THE CORD SET.** A serious shock or fire hazard may result along with computer malfunctions. See Grounding Instructions, page 3.

- Do not operate treadmill on deeply padded, plush or shag carpet. Damage to both carpet and treadmill may result.
- Do not block the rear of the treadmill. Provide a minimum of 3 1/2 feet clearance between the rear of the treadmill and any fixed object.
- Keep children away from the treadmill. There are obvious pinch points and other caution areas that can cause harm.
- Keep hands away from all moving parts.
- Never operate the treadmill if it has a damaged cord or plug. If the treadmill is not working properly, call your dealer.
- Keep the cord away from heated surfaces.
- Do not operate where aerosol spray products are being used or where oxygen is being administered. Sparks from the motor may ignite a highly gaseous environment.
- Never drop or insert any object into any openings.
- Do not use outdoors.
- To disconnect, turn all controls to the off position, remove tether cord, then remove the plug from the outlet.
- Do not attempt to use your treadmill for any purpose other than for the purpose it is intended.
- The pulse sensors are not medical devices. Various factors, including the user's movements, may affect the accuracy of heart rate readings. The pulse sensors are intended only as exercise aids in determining heart rate trends in general.
- Use handrails provided; they are for your safety.
- Wear proper shoes. High heels, dress shoes, sandals or bare feet are not suitable for use on your treadmill. Quality athletic shoes are recommended to avoid leg fatigue.

**Remove tether cord after use to prevent unauthorized treadmill operation.
SAVE THESE INSTRUCTIONS - THINK SAFETY!**

Important Electrical Information

WARNING!

- **NEVER** use a ground fault circuit interrupt (GFCI) wall outlet with this treadmill. Large switching currents of the drive motor will trip GFCI type outlets, as will any appliance with a large motor. Route the power cord away from any moving part of the treadmill including the elevation mechanism and transport wheels.
- **NEVER** remove any cover without first disconnecting AC power.
- If voltage varies by ten percent (10%) or more the performance of your treadmill may be affected. **Such conditions are not covered under your warranty.** If you suspect the voltage is low, contact your local power company or a licensed electrician for proper testing.
- **NEVER** expose this treadmill to rain or moisture. This product is **NOT** designed for use outdoors, near a pool or spa, or in any other high humidity environment. The operating temperature specification is 40 to 120 degrees Fahrenheit and humidity limit is 95%, non-condensing (no water drops forming on surfaces).

Grounding Instructions

This product must be grounded. If the treadmill should malfunction or breakdown, grounding provides a path of least resistance for electric current, reducing the risk of electric shock. This product is equipped with a cord having an equipment-grounding plug. The plug must be plugged into an appropriate outlet that is properly installed and grounded in accordance with all local codes and ordinances.

DANGER - Improper connection of the equipment-grounding conductor can result in a risk of electric shock. Check with a qualified electrician or serviceman if you are in doubt as to whether the product is properly grounded. Do not modify the plug provided with the product if it will not fit the outlet, have a proper outlet installed by a qualified electrician.

This product is for use on a nominal 120-volt circuit, and has a grounding plug that looks like the plug illustrated below. A temporary adapter that looks like the adapter illustrated below may be used to connect this plug to a 2-pole receptacle as shown below if a properly grounded outlet is not available. The temporary adapter should be used only until a properly grounded outlet, (below) can be installed by a qualified electrician. The green colored rigid ear-lug, or the like, extending from the adapter, must be connected to a permanent ground such as a properly grounded outlet box cover. Whenever the adapter is used, it must be held in place by a metal screw.

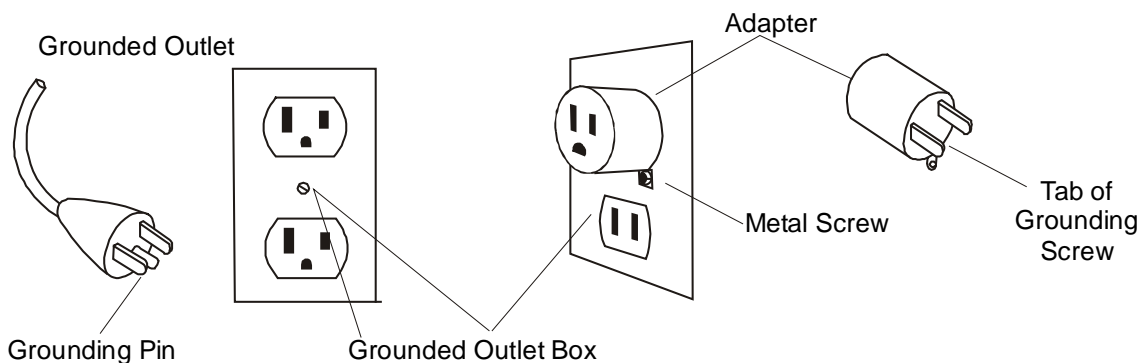

Important Operation Instructions

- **NEVER** operate this treadmill without reading and completely understanding the results of any operational change you request from the computer.
- Understand that changes in speed and incline do not occur immediately. Set your desired speed on the computer console and release the adjustment key. The computer will obey the command gradually.
- **NEVER** use your treadmill during an electrical storm. Surges may occur in your household power supply that could damage treadmill components.
- Use caution while participating in other activities while walking on your treadmill, such as watching television, reading, etc. These distractions may cause you to lose balance or stray from walking in the center of the belt, which may result in serious injury.
- **NEVER** mount or dismount the treadmill while the belt is moving. Spirit treadmills start with at a very low speed and it is unnecessary to straddle the belt during start up. Simply standing on the belt during slow acceleration is proper after you have learned to operate the unit.
- Always hold on to a handrail or hand bar while making control changes (incline, speed, etc.). Do not use excessive pressure on console control keys. They are precision set to function properly with little finger pressure. Pushing harder is not going to make the unit go faster or slower. If you feel the buttons are not functioning properly with normal pressure contact your Spirit dealer.

Safety Tether Cord

A safety tether cord is provided with this unit. It is a simple magnetic design that should be used at all times. It is for your safety should you fall or move too far back on the tread-belt. Pulling this safety tether cord will stop tread-belt movement.

To Use:

1. Place the magnet into position on the round metal portion of the console control head. Your treadmill will not start and operate without this. Removing the magnet also secures the treadmill from unauthorized use.
2. Fasten the plastic clip onto your clothing securely to assure good holding power. **Note:** The magnet has strong enough power to minimize accidental, unexpected stopping. The clip should be attached securely to make certain it does not come off. Be familiar with its function and limitations. The treadmill will stop, depending on speed, with a one to two step coast anytime the magnet is pulled off the console. Use the red Stop / Pause switch in normal operation.

Assembly Pack Check List (ET8 / ET6)



5x 16m/m
Screw (6 pcs)



M5
Speed Nut (6 pcs)

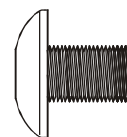

5/16" x1/2"
Button Head Socket Bolt (12 pcs)

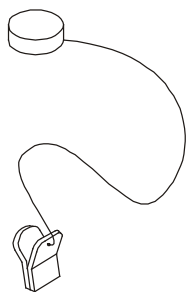

Safety Key (1pc)

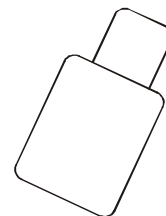

Lubricant (1pc)

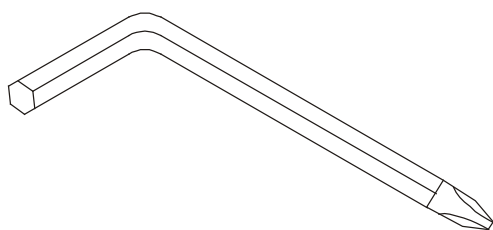

Combination M5 Allen Wrench
& Phillips Head Screw Driver (1 pc)

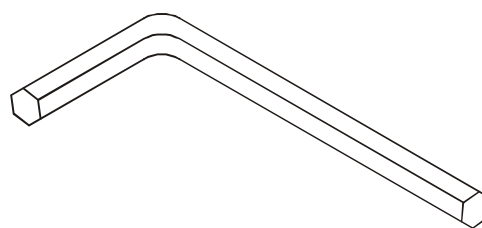

M6 Allen Wrench (1pc)

Assembly Instructions (ET8 / ET6)

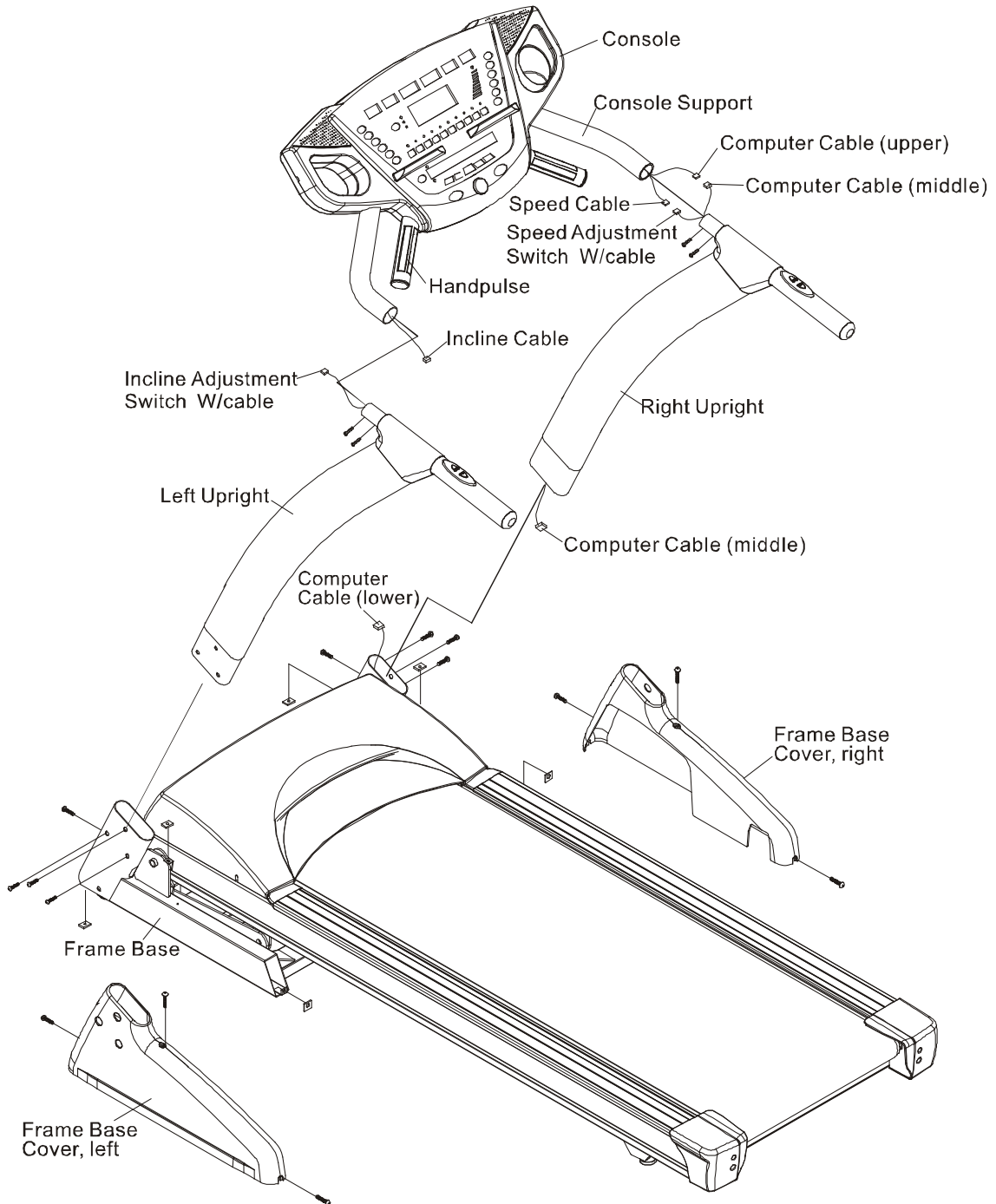

!!ATTENTION: IMPORTANT UNPACKING INSTRUCTIONS. PLEASE READ BEFORE UNPACKING YOUR FOLDING TREADMILL!!

Serious injury could occur if this folding treadmill is not unpacked properly.

There is a Velcro strap installed around the treadmill base that prevents the treadmill from unfolding accidentally during shipping. If this strap is not removed properly the treadmill could spring open unexpectedly and cause injury if someone is standing near the treadmill when the strap is removed.

To ensure your personal safety during removal of the shipping strap please make sure the treadmill is positioned flat on the ground, in the orientation it would be in if you were using the treadmill. Do not turn the treadmill up on its side while removing the shipping strap. This could cause the treadmill's folding mechanism to spring open. If the end of the Velcro strap (that you need to grab to remove it) happens to be under the treadmill deck, reach under the deck to grab it, but do not tilt the treadmill up to gain access to the strap end.

Assembly (ET6 / ET8)

■ STEP 1

Remove all parts from the carton.

Locate the left and right frame base covers. Insert six M5 Speed Nuts on the small plates.

Install the cover and use six 5 x 16mm Screws to fasten.

■ STEP 2

Connect the lower Computer Cable with the middle Computer Cable.

■ STEP 3

Hand tighten Right and Left Uprights into the Frame Base with eight 5/16" x 1/2"

Button Head Socket Bolts, by using the Combination M5 Allen Wrench & Phillips Head Screwdriver

■ STEP 4

Connect the middle Computer Cable with the upper Computer cable.

Connect the Speed Switch Cable with the upper Speed Cable from the console.

Connect the Incline Switch Cable with the upper Incline Cable from the console.

■ STEP 5

Install the Console Support into the Right and Left Handrails with four 5/16" x 1/2"

Button Head Socket Bolts by using the Combination M5 Allen Wrench & Screwdriver.

■ PLEASE LOCK DOWN ALL HARDWARE AFTER THE ACCESSORIES HAVE BEEN ASSEMBLED.

Assembly Pack Check List (ET10)

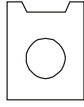

M5
Speed Nut (4 pcs)

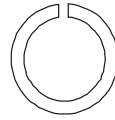

3/8" x 2T
Split Washer (2)

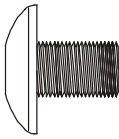

5/16" x 1/2" Button Head
Socket Bolt (10 pcs)



5 x 16 m/m
Screw (2 pcs)

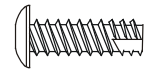

5 x 16 m/m
Tapping Screw (6 pcs)

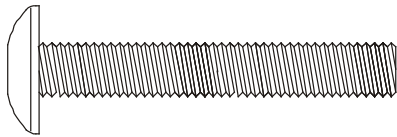

3/8" x 2" Button Head
Socket Bolt (2 pcs)

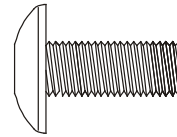

5/16" x 3/4" Button Head
Socket Bolt (4 pcs)

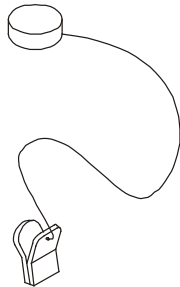

Safety Key (1pc)

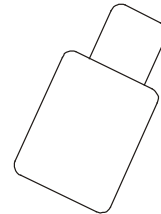

Lubricant (1pc)

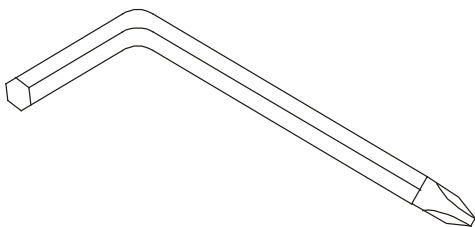

Combination M5 Allen Wrench
& Phillips Head Screw Driver (1 pc)

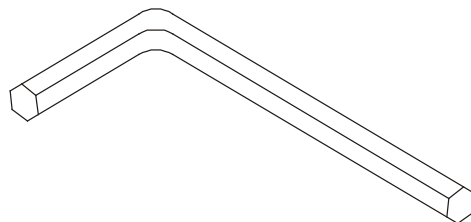

M6 Allen Wrench (1pc)

Assembly Instructions (ET10)

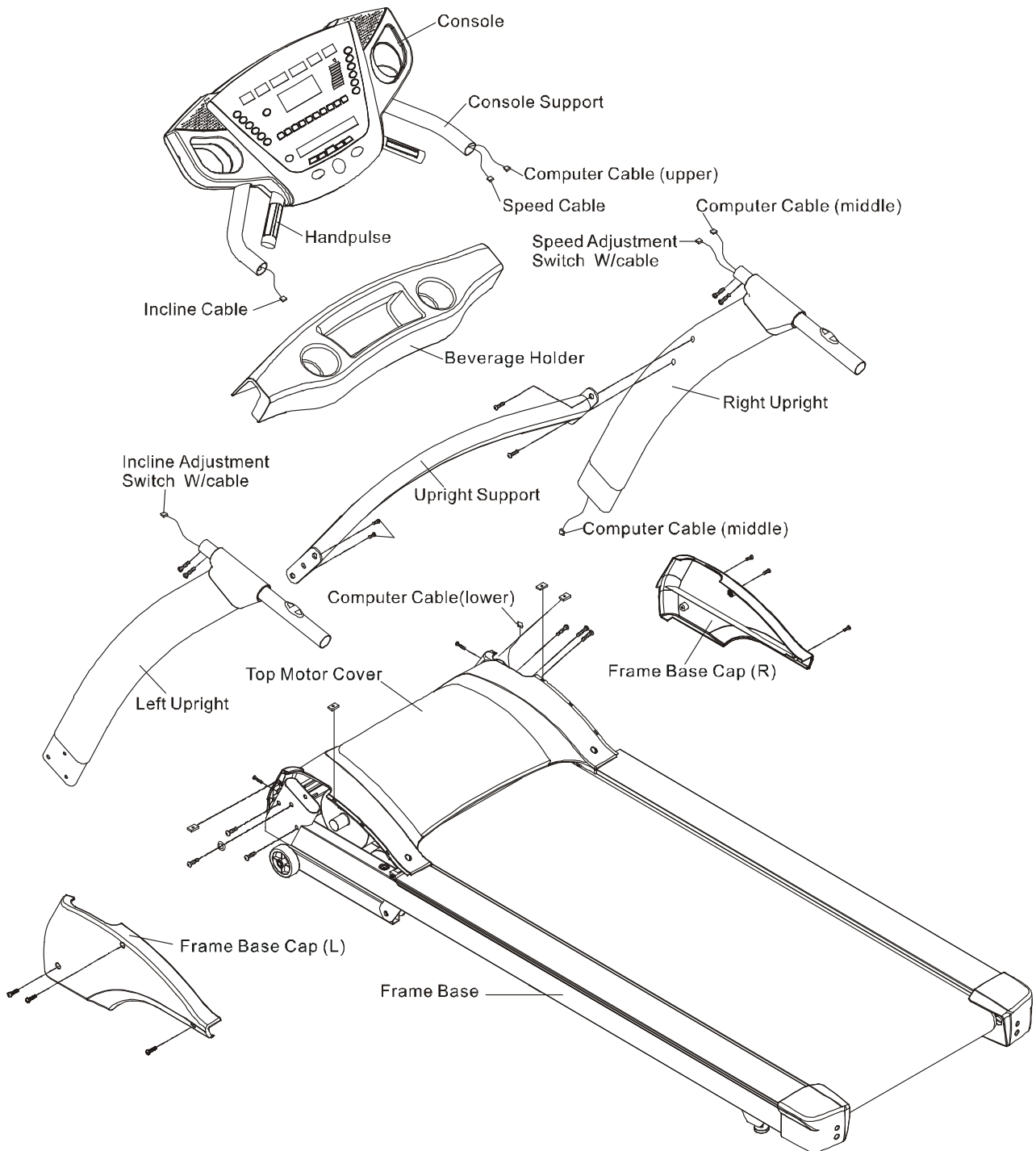

Assembly (ET10)

■ STEP 1

Remove all parts from the carton.

■ STEP 2

Connect the lower Computer Cable with the upper Computer Cable.

■ STEP 3

Hand tighten Right and Left Uprights into Main Frame with two 3/8" x 2" Button Head Socket Bolts, two 3/8" x 2T Split Washers and six 5/16" x 1/2" Button Head Socket Bolts by using the Combination M5 Allen Wrench & Phillips Head Screwdriver and M6 Allen Wrench.

■ STEP 4

Install the Upright Support onto the Left and Right Uprights with four 5/16" x 3/4" Button Head Socket Bolts, by using the Combination M5 Allen Wrench & Phillips Head Screwdriver.

■ STEP 5

Connect the middle Computer Cable with the upper Computer cable from the console.
Connect the Speed Switch Cable with the upper Speed Cable from the console.
Connect the Incline Switch Cable with the upper Incline Cable from the console.

■ STEP 6

Install the Console Support into the Right and Left Uprights with four 5/16" x 1/2" Button Head Socket Bolts, by using the Combination M5 Allen Wrench & Phillips Head Screwdriver. Then Install the Beverage Holder onto the Console Support. * **Tighten all screws installed in STEP 4.**

■ STEP 7

Install the **four** speed Nuts into side of the Top Motor Cover.

■ STEP 8

Install Frame Base Cap (R) and Frame Base Cap (L) with two 5 x 16 m/m Tapping Screws and four 5 x 16 m/m Tapping Screws by using the Combination M5 Allen Wrench & Phillips Head Screwdriver.

■ PLEASE LOCK DOWN ALL HARDWARE AFTER THE ACCESSORIES HAVE BEEN ASSEMBLED.

ET6 / ET8 Folding Instructions

Do not attempt to move the unit unless it is in the folded and locked position. Be sure the power cord is secured to avoid possible damage. Use both handrails to maneuver the unit to the desired position.

■ To Fold The Treadmill:

Make certain the treadmill is at minimum incline. Lift the treadmill running deck until it is secured by the locking telescoping tube assembly in the center of the rear of the running deck.

■ To Unfold The Treadmill:

Apply slight forward pressure* on the treadmill running deck with one hand. Pull down on the unlocking lever and slowly lower the running deck to the floor. The deck will lower unassisted when it reaches about waist high.

*At the rear roller area to relieve pressure on the locking system.

Transport

■ ET6/ET8

The treadmill is equipped with four transport wheels that are engaged when the treadmill is folded. After folding simply roll the treadmill away.

■ ET10

Carefully lift the treadmill at the rear roller area, grasping the two side end caps, and roll the treadmill away.

Operation of Your Treadmill

Getting familiar with the control panel

■ ET6 Console



■ ET8 / ET10 Console



Getting Started:

Power the treadmill on by plugging it into an appropriate wall outlet, then turn on the power switch located at the front of the treadmill below the motor hood. Ensure that the safety key is installed, as the treadmill will not power on without it.

When the power is turned on, all the lights on the display will light for a short time. Then the **Time** and **Distance** windows will display Odometer readings for a short time. The **Time** window will show how many hours the treadmill has been in use and the **Distance** window will show how many miles (or Kilometers if the treadmill is set to metric readings) the treadmill has gone. Then a message will scroll across the message showing the current software version. The treadmill will then enter idle mode, which is the starting point for operation.

Quick-Start Operation:

STEP 1: Press and release the **Start** key to wake display up (**if not already on**).

Note: Installing the tether key will also wake up the console.

STEP 2: Press and release the **Start** key to **begin belt movement**, at .5 mph, then adjust to the desired speed using the **Fast / Slow** keys (console or hand rail). You may also use the rapid speed keys 2 through 12 to adjust the speed.

STEP 3: To slow tread-belt press and hold the **Slow** key (console or hand rail) to the desired speed. You may also press the rapid speed adjust keys, 2 through 12.

STEP 4: To stop the tread-belt press and release red **Stop** key.

Pause/Stop/Reset Feature:

STEP 1: When the treadmill is running the pause feature may be utilized by pressing the red **Stop** key once. This will slowly decelerate the tread-belt to a stop. The incline will go to zero percent. The Time, Distance and Calorie readings will hold while the unit is in the pause mode. After 5 minutes the display will reset and return to the start up screen.

STEP 2: To resume your exercise, when in Pause mode, press the **Start** key. The speed and incline will return to their previous settings.

Pause is executed when the **Stop** button is pressed once. If the **Stop** key is pressed a second time, the program will end and a workout summary will be displayed. If the **Stop** button is pressed a third time, the console will return to the idle mode (start up) screen. If the **Stop** button is held down for more than 3 seconds the console will reset.

Incline Feature:

- | Incline may be adjusted anytime after belt movement.
- | Press and hold the **Adjust** ▲▼ keys (console or hand rail) to achieve desired level of effort. You may also choose a more rapid increase / decrease by selecting desired key, 2 through 12, on left hand side of console (incline).
- | The display will indicate incline percent as adjustments are made.
- | Incline will remain in its position when display is turned off.

Dot Matrix Center Display (Manual Operation):

Twenty rows of LED dots (8 high) indicate each segment of a workout. The dots are only to show an approximate level (speed/incline) of effort. They do not necessarily indicate a specific value - only an approximate percent to compare levels of intensity. In Manual Operation the Speed / Incline dot matrix window will build a profile "picture" as values are changed during a workout. Next to the Dot Matrix window are three LEDs labeled: Track, Speed and Incline, along with a Display button. When the Track LED is lit the Dot matrix displays the Track profile, when the Speed LED is lit the Dot matrix displays the Speed profile and when the Incline LED is lit the Dot Matrix displays the Incline profile. You may change the Dot Matrix profile view by pressing the Display button. After scrolling through the three profiles, by pressing the Display button, the Dot matrix will automatically scroll through the three displays showing each one for four seconds. The LED associated with each profile will blink while that view is displayed. One more press of the Display button will return you to the Track profile.

1/4-Mile Track:

The 1/4-mile track will be displayed around the dot matrix window. The flashing dot indicates your progress. Once the 1/4-mile is complete this feature will begin again.

Pulse Grip Feature:

The Pulse (Heart Rate) console window will display your current heart rate in beats per minute during the workout. You must use both stainless steel sensors on the front cross bar to display your pulse. Pulse value displays anytime the upper display is receiving a Grip Pulse signal. You may not use the Grip Pulse feature while in Heart Rate Control.

Calorie Display:

Displays the cumulative calories burned at any given time during your workout. **Note:** This is only a rough guide used for comparison of different exercise sessions, which cannot be used for medical purposes.

To Turn Treadmill Off:

- (1) Display will automatically turn off (go to sleep) after 30 minutes (no key operations). The treadmill will draw very little current in sleep mode (about as much as your television when it is turned off).
- (2) Remove tether cord.
- (3) Turn of the main switch on the front of the treadmill, below the motor cover.

Programmable Features

The New Spirit treadmills offer 7 factory preset programs, 2 user defined programs and one Manual program.

Each preset program has a maximum speed level that is displayed when a desired workout is chosen. The maximum speed that the particular program will achieve will be displayed in the Speed window.

Also included are two user programs (User 1 and User 2) for custom workouts.

To Select a Program:

STEP 1: Press the desired **PROGRAM** key. Press enter to select the program. The display will prompt you through the programming or you can just press Start to begin the program with default values.

STEP 2: If enter was pressed, the **Time** window will blink with the program time. You may use any of the up/down keys to adjust the time. After adjusting, or to accept the default, press enter. (Note: You may press start at any time during the programming to start the program.)

STEP 3: The **Calorie** window will now be blinking a value, indicating your **Body Weight**. Entering the correct body weight will affect the calorie count. Use the Up/Down keys to adjust, then press enter.

A note about the **Calorie** display: No exercise machine can give you an exact calorie count because there are too many factors which determine exact calorie burn for a particular person. Even if someone is the exact same body weight, age and height, their calorie burn may be very different than yours. The **Calorie** display is to be used as a reference only to monitor improvement from workout to workout.

STEP 4: The **Heart Rate** window will now be blinking a value, indicating your **Age**.

Entering your correct age affects the heart rate **Bar Graph Display (ET8 / ET10 only)** and the **Heart Rate Control** programs. Use the Up/Down keys to adjust, then press enter. Your age determines the maximum heart rate you may achieve. Since the Bar Graph Display and the Heart Rate control features are based on a percentage of your maximum heart rate, it is important to enter the correct age for these features to work properly.

STEP 5: The **Speed** window will now be blinking the preset top speed of the selected program. Use the Up/Down keys to adjust, then press enter. Each program has various speed changes as you progress through the profile; this allows you to limit the highest speed the program can reach.

Now press the start button to begin your workout.

User Programs:

STEP 1: Select User 1 or User 2 via the **PROGRAM** key then press **Enter**. Note that the dot matrix display portion will have a single row of dots at the bottom (Unless there is a previously stored program).

STEP 2: Note the clock (Time) window is flashing. Use the **Adjust** keys to adjust up from 10 minutes (if desired). Press **ENTER** key. This is a must to continue even if time is not adjusted.

STEP 3: The Calorie window will now be blinking a bodyweight value. Enter your bodyweight and press **Enter**.

STEP 4: The Pulse window will now be blinking an Age value. Adjust the age and press enter.

STEP 5: The first column (segment) will now be blinking. Using the **Fast / Slow** keys, adjust the speed level to your desired effort for the first segment then press enter. The second column will now be blinking. Repeat the above process until all segments have been programmed. The first column will be blinking again. This is for the incline programming. Repeat the above process to program all segments for incline.

STEP 6: Press the **Start** button to begin the workout and also save the program to memory.

Target Heart Rate

● The old motto, “no pain, no gain”, is a myth that has been overpowered by the benefits of exercising comfortably. A great deal of this success has been promoted by the use of heart rate monitors. With the proper use of a heart rate monitor, many people find that their choice of exercise intensity is either too high or too low and exercise is much more enjoyable by maintaining their heart rate in the desired benefit range.

● To determine the benefit range in which you wish to train, you must first determine your Maximum Heart Rate. This can be accomplished by using the following formula: $220 - \text{User's Age} = \text{Maximum Heart Rate}$.

If you enter your age during programming of the console the console will perform this calculation automatically. This is used for the HR control programs and also for the Heart rate bar graph (ET8/ ET10 only) After calculating your Maximum Heart Rate, you can decide upon which goal you would like to pursue. The two most popular reasons for, or goals of exercise, are cardiovascular fitness (training for the heart and lungs) and weight control. The black columns on the chart above represent the Maximum Heart Rate for a person whose age is listed at the bottom of each column.

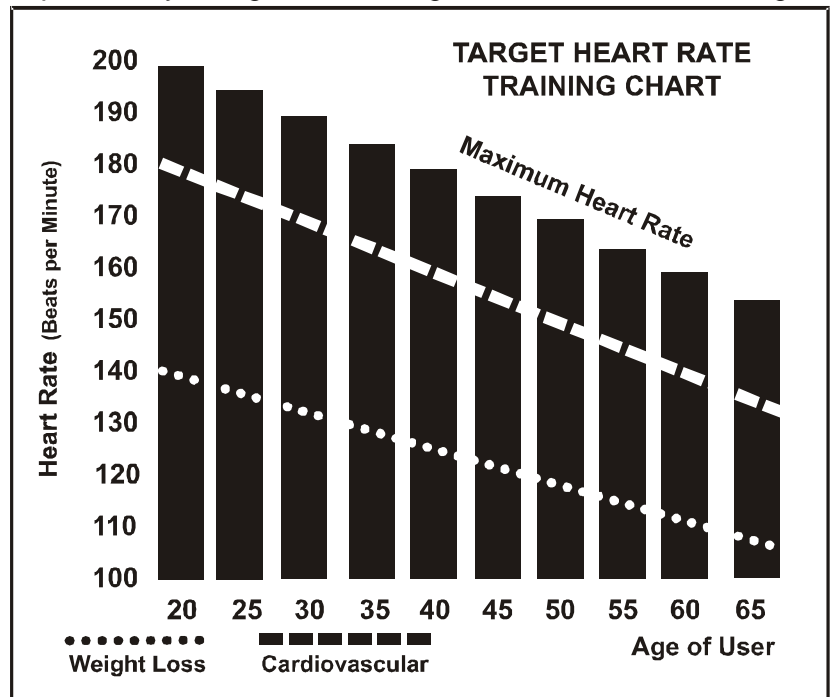

The heart rate training zone for either cardiovascular fitness or weight loss is represented by two different lines, which cut diagonally through the chart. A definition of the lines' goal is in the bottom left-hand corner of the chart. If your goal is cardiovascular fitness or if it is weight loss, it can be achieved by training at 90% or 70%, respectively, of your Maximum Heart Rate on a schedule approved by your physician. Consult your physician before participating in any exercise program.

With all Spirit Heart Rate Control treadmills, you may use the heart rate monitor feature without using the Heart Rate Control program. This function can be used during manual mode or during any of the nine different programs. The Heart Rate Control program automatically controls incline.

CAUTION!

The target value used in H-1 and H-2 programs is a suggestion only for normal, healthy individuals. Do not exceed your limits! You may not be able to obtain your chosen target. If in question, enter a higher age value that will set a lower target goal.

Using a Heart Rate Transmitter (sold separately)

How to wear your wireless chest strap transmitter:

1. Attach the transmitter to the elastic strap using the locking parts.
2. Adjust the strap as tightly as possible as long as the strap is not too tight to remain comfortable.
3. Position the transmitter with the **Polar** logo centered in the middle of your body facing away from your chest (some people must position the transmitter slightly left of center). Attach the final end of the elastic strap by inserting the round end and, using the locking parts, secure the transmitter and strap around your chest.
4. Position the transmitter immediately below the pectoral muscles.
5. Sweat is the best conductor to measure very minute heart beat electrical signals. However, plain water can also be used to pre-wet the electrodes (2 black square areas on the reverse side of the belt and either side of transmitter). It's also recommended that you wear the transmitter strap a few minutes before your work out. Some users, because of body chemistry, have a more difficult time in achieving a strong, steady signal at the beginning. After "warming up", this problem lessens. As noted, wearing clothing over the transmitter/strap doesn't affect performance.
6. Your workout must be within range - distance between transmitter/receiver – to achieve a strong steady signal. The length of range may vary somewhat but generally stay close enough to the console to maintain good, strong, reliable readings. Wearing the transmitter immediately against bare skin assures you of proper operation. If you wish, you may wear the transmitter over a shirt. To do so, moisten the areas of the shirt that the electrodes will rest upon.

Erratic Operation:

Caution! Do not use this treadmill for Heart Rate Control unless a steady, solid Actual Heart Rate value is being displayed. High, wild, random numbers being displayed indicate a problem.

Areas to look for on interference:

- (1) Treadmill not properly grounded - **A must!**
- (2) Microwave ovens, T.V.'s, small appliances, etc.
- (3) Fluorescent lights.
- (4) Some household security systems.
- (5) Perimeter fence for a pet.
- (6) The antenna that picks up your heart rate is very sensitive. If there is an outside noise source, turning the whole machine 90 degrees may de-tune the interference.
- (7) If you continue to experience problems contact your dealer.

WARNING!

DO NOT USE THE HEART RATE CONTROL PROGRAM IF YOUR HEART RATE IS NOT REGISTERING PROPERLY ON THE TREADMILL'S DISPLAY!

Special Operations of Heart Rate Functions:

All Spirit treadmills that are factory equipped with a Heart Rate Control system have many distinct features both in the Heart Rate Control program and during heart rate monitoring. This section will give you a more detailed background to use your treadmill in the most effective manner.

Heart Rate Control

How the Heart Rate Control Program Works:

Heart Rate Control (HRC) uses your treadmill's speed and incline systems to adjust your heart rate. Increases and decreases in elevation affect heart rate much more efficiently than changes in speed alone. The HRC program automatically changes the speed and elevation gradually to achieve the programmed target heart rate.

Heart rate Auto-Pilot feature (ET8 / ET10 only)

This unique feature allows the user to instantly enter the Heart Rate Control mode at any time with the press of a button. The HR2 program button also doubles as the Auto-Pilot button. During any program the user may press the Auto-Pilot button to enter the HRC program. Your current heart rate (the heart rate you are at when you press Auto-Pilot) will be maintained automatically by the Auto-Pilot program. You may press the elevation/incline up or down buttons to change your target heart rate while in the Auto-Pilot mode.

Selecting a Heart Rate Control Program:

You have the option, during the setup mode, to choose either the Weight Control (H-1) program or the Cardiovascular (H-2) program. Weight Control attempts to maintain your heart rate at 70% of your Maximum Heart Rate. Cardiovascular attempts to maintain your heart rate at 90% of your Maximum Heart Rate. Your Maximum Heart Rate is based upon a formula that subtracts your age from 220. Your age input is performed during the setup mode.

CAUTION!

The target value used in H-1 and H-2 programs is a suggestion only for normal, healthy individuals. Do not exceed your limits! You may not be able to obtain your chosen target. If in question, enter a higher age value that will set a lower target goal.

Heart Rate Control programming

CAUTION!

Intended for wireless transmitter chest strap only. Do not use Pulse Grip bar for Heart Rate Control. You must receive a strong / steady value in heart rate window.

STEP 1: Press HR1 or HR2 button.

STEP 2: The Pulse window will be blinking, showing the default HR for this program. You may adjust it and press enter if you want or just press enter to accept the default value.

STEP 3: The Calorie will now be blinking showing bodyweight. Adjust and press enter or press enter to accept default.

STEP 4: The Pulse window will now be blinking showing age. Adjust and press enter or press enter to accept default. Adjusting Age will change the Target HR value.

STEP 5: The Time window will now be blinking. Adjust the time and press enter.

STEP 6: Press Start to begin program.

During the program you may increase or decrease the target heart rate by pressing the elevation/incline up or down buttons.

General Maintenance

Belt and Bed - Your treadmill uses a very high-efficient low-friction bed. Performance is maximized when the bed is kept as clean as possible. Use a soft, damp cloth or paper towel to wipe the edge of the belt and the area between the belt edge and frame. Also reach as far as practical directly under the belt edge. This should be done once a month to extend belt and bed life. Use water only - no cleaners or abrasives. A mild soap and water solution along with a nylon scrub brush will clean the top of the textured belt. **Allow to dry before using.**

Belt Dust - This occurs during normal break-in or until the belt stabilizes. Wiping excess off with a damp cloth will minimize buildup.

General Cleaning - Dirt, dust, and pet hair can block air inlets and accumulate on the running belt. On a monthly basis, vacuum underneath your treadmill to prevent the buildup of dirt that can be sucked into the motor area while the treadmill is running. Once a year, you should remove the black motor hood and vacuum out dirt that may accumulate. **UNPLUG POWER CORD BEFORE THIS TASK.**

BELT ADJUSTMENTS:

Tread-belt Tension Adjustment - Belt tension is not critical for most users. It is very important for joggers and runners in order to provide a smooth, steady running surface. Adjustment must be made from the right side of the rear roller in order to adjust tension with the 6 mm Allen wrench provided in the parts package. The adjustment bolt is located at the end of the right side rail as noted in diagram below.

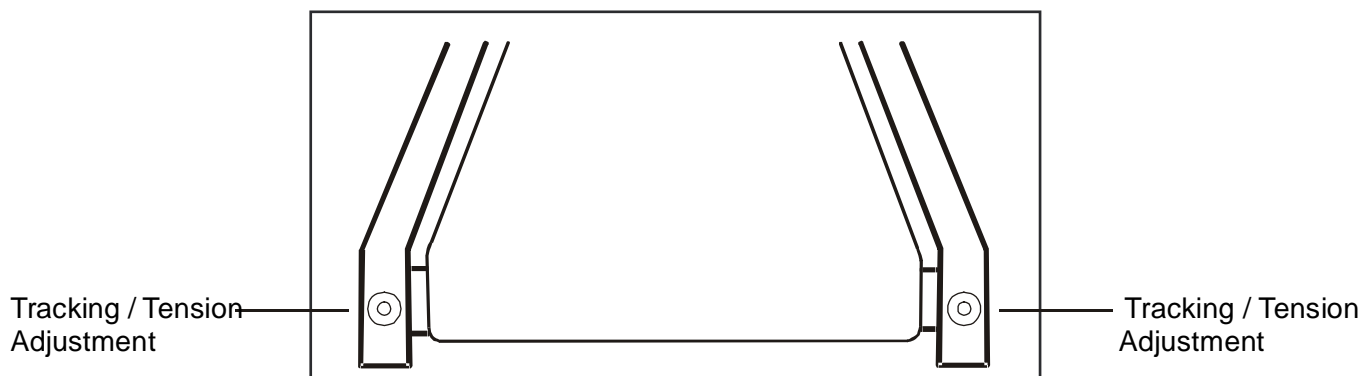

Note: Adjustment is through small hole in end

Tighten the rear roller only enough to prevent slippage at the front roller. Turn the tread-belt tension adjusting bolt in increments of 1/4 turn and inspect for proper tension.

When an adjustment is made to the belt tension, you must also make a tracking adjustment to compensate for the change in belt tension. This is accomplished by turning both the tension and tracking Allen bolts an equal amount. This adjustment should be made by turning both bolts clockwise by no more than a 1/4 turn at a time.

DO NOT OVERTIGHTEN – Over tightening will cause belt damage and premature bearing failure.

TREADBELT TRACKING ADJUSTMENT:

The performance of your treadmill is dependent on the frame running on a reasonably level surface. If the frame is not level, the front and back roller cannot run parallel, and constant belt adjustment may be necessary.

The treadmill is designed to keep the tread-belt reasonably centered while in use. It is normal for some belts to drift near one side while the belt is running with no one on it. After a few minutes of use, the tread-belt should have a tendency to center itself. If, during use, the belt continues to move toward one side, adjustments are necessary.

TO SET TREADBELT TRACKING:

A 6 mm Allen wrench is provided to adjust the rear roller. Make tracking adjustments from the **left** side only. Set belt speed at approximately 2 to 3 mph. A small adjustment can make a dramatic difference. Turn the bolt only a 1/4 turn and wait a few minutes for the belt to adjust itself. Continue to make 1/4 turns until the belt stabilizes in the center of the running deck. The belt may require periodic tracking adjustment depending on use and walking/running characteristics. Some users will affect tracking differently. Expect to make adjustments as required to center the tread-belt. Adjustments will become less of a maintenance concern as the belt is used. Proper belt tracking is an owner responsibility common with all treadmills.

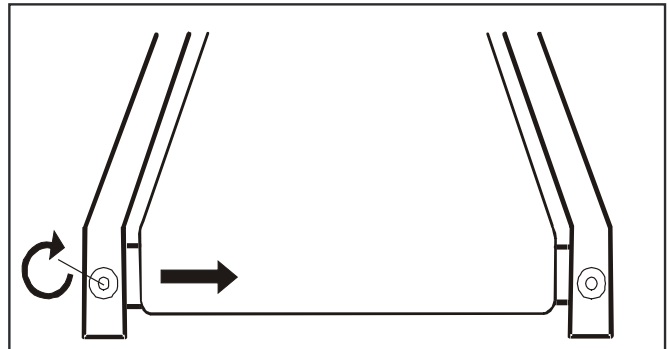

ATTENTION:

DAMAGE TO THE RUNNING BELT RESULTING FROM IMPROPER TRACKING / TENSION ADJUSTMENTS IS NOT COVERED UNDER THE SPIRIT WARRANTY.

BELT / DECK LUBRICATION:

Do not lubricate with other than Spirit approved lubricant. Your treadmill comes with one tube of lubricant and extra tubes can be ordered directly from Spirit. There are commercially available lube kits, but the only one currently approved by Spirit is Lube-N-Walk. These kits come with an application wand that makes applying the lubrication easier. The kits can be purchased from Spirit or directly from Lube-N-Walk here: <http://www.jadfitness.com/>

Keeping the deck lubricated at the recommended intervals ensures the longest life possible for your treadmill. If the lubricant dries out, the friction between the belt and deck rises and places undue stress on the drive motor, drive belt and electronic motor control board, which could result in catastrophic failure of these expensive components. Failure to lubricate the deck at regular intervals may void the warranty.

The deck comes pre-lubricated and subsequent lubrication should be performed every 180 hours of use. The console has a built in lubrication reminder indicator that lights every 180 hours of use. To lubricate the deck with the tube of lubricant supplied it will be necessary to loosen the walking belt. Using the 6 mm allen wrench supplied, loosen the two rear roller adjustment bolts -- located in the rear end caps -- enough to get your hand under the belt (5 –10 turns). Make sure to loosen both bolts the same amount of turns and also remember how many turns, because when finished you will need to tighten the bolts back to the point they were before.

Once the belt is loose, wipe the deck with a clean lint free cloth to remove any dirt. Apply the whole tube of lubricant onto the deck surface about 18 inches from the motor cover. Squeeze out the contents of the tube across the deck (parallel to the motor cover) in about a one-foot line, like toothpaste on a toothbrush. The one-foot line should be in the middle of the deck at approximately equal distance from both side edges of the belt. You want the lubricant to be applied about the spot that your feet would hit the belt as you are walking. This should be about 18 inches from the motor cover, but you may want to walk on the treadmill before loosening the belt to note where your feet land on the belt. If you mostly run on the treadmill the spot where your feet land may be different from walking.

Once the lubricant is applied, tighten the rear roller bolts the same amount of turns as when you loosened them. Run the treadmill at about 6 mph without walking on it for about a minute or two to make sure the belt stays in the middle of the deck. If the belt tracks to one side then follow the belt tracking instructions to remedy. Now the deck is lubricated and you should walk, not run, on the treadmill immediately for at least 5 minutes to ensure the lubricant is evenly distributed. If you purchase a Lube-N-Walk kit, follow the instructions that come with it to apply the lubrication.

Service Checklist - Diagnosis Guide

Before contacting your dealer for aid, please review the following information. It may save you both time and expense. This list includes common problems that may not be covered under the treadmill's warranty.

PROBLEM	SOLUTION/CAUSE
Display does not light	Tether cord not in position. Circuit breaker on front grill tripped. Push circuit breaker in until it locks. Plug is disconnected. Make sure plug is firmly pushed into AC household wall outlet. Household circuit breaker may be tripped. Treadmill defect. Contact your Spirit dealer.
Treadbelt does not stay centered Treadmill belt hesitates when walked/run on	A user may be walking while favoring or putting more weight on either the left or right foot. If this walking pattern is natural, track the belt slightly off-center to the side opposite from the belt movement. See General Maintenance section on Treadbelt Tension. Adjust as necessary.
Motor is not responsive / Display is lit	Make certain clock is running.
Treadmill will only achieve approximately 7 mph but shows higher speed on display	This indicates motor should be receiving power to operate. Low AC voltage to treadmill. Do not use an extension cord. If an extension cord is required it should be as short as possible and heavy duty 16 gauge minimum. Low household voltage. Contact an electrician or your Spirit dealer. A minimum of 110 volt AC current is required.
Treadbelt stops quickly/suddenly when tether cord is pulled	High belt/deck friction. See General Maintenance section on lubrication.
Treadmill trips on board 15 amp circuit	High belt/deck friction. See General Maintenance
Computer shuts off when console is touched (on a cold day)while walking/running	Treadmill is not grounded. Static electricity is "crashing" the computer. Refer to Grounding Instructions on page 4.

Calibration procedure:

- 1) Remove the safety key
- 2) Press and hold down the Start and Fast (speed up) buttons with one hand and replace the safety key with the other. Continue to hold the Start and Fast key until the window displays “Factory settings”, then press the enter key.
- 3) You will now be able to set the display to show Metric or English settings. To do this press the up or down key to show which you want, then press enter.
- 4) Make sure the wheel size diameter is 2.81 (**2.98 for ET10**) then press enter
- 5) Adjust the minimum speed (if needed) to 0.5 and then press enter
- 6) Adjust the maximum speed (if needed) to 12.0 and then press enter
- 7) Adjust the maximum elevation (if needed) to 15 and then press enter
- 8) Press start to begin calibration. The process is automatic. The belt speed will start without warning; so do not stand on the belt.

Adjusting the speed sensor:

If the calibration does not pass you may need to check the speed sensor alignment.

- 1) Remove the motor cover hood.
- 2) The speed sensor is located on the left side of the frame, right next to the front roller pulley (the pulley will have a belt around it that also goes to the motor). The speed sensor is small and black with a wire connected to it.
- 3) Make sure the sensor is as close as possible to the pulley without touching it. You will see a magnet on the face of the pulley; make sure the sensor is aligned with the magnet. There is a screw that holds the sensor in place that needs to be loosened to adjust the sensor. Re-tighten the screw when finished.

Maintenance menu:

- 1) Press and hold the Start, Stop and Enter key at the same time, until the display shows “Engineering mode” (it may say maintenance menu, depending on version). Press the Enter key.
- 2) You can now scroll through the menu using the up and down keys. Use the Stop key to return to previous menu selection. The menu selections are:
 - 1) **Calibration** (used to verify calibration)
 - 2) **Factory settings** (These should not be changed unless instructed by Spirit service department)
 - 3) **Security** (This allows you to lock the console keyboard)
 - 4) **Functions**
 - i. **Sleep** (turns sleep mode on or off)
 - ii. **Pause** (turns pause mode on or off)
 - iii. **Maintenance** (reset lube message and odometer readings)
 - iv. **Units** (set display to English or Metric readings)
 - v. **Grade return** (returns the elevation to lowest setting when pause is pressed)
 - 5) **Display test** (lights all LED lights for testing)
 - 6) **Key test** (tests that all keys are functioning)

Manufacturer's Limited Warranty

Effective October 15, 2007 TREADMILL WARRANTY

Spirit Manufacturing Inc. warrants all its treadmill parts, for a period of time listed below, from the date of retail sale, as determined by sale receipt, or in the absence of a receipt eighteen (18) months from the original factory shipping date. Spirit's responsibilities include providing new or remanufactured parts, at Spirit's option, and technical support to our independent dealers and servicing organizations. In the absence of a dealer or service organization these warranties will be administered by Spirit directly to the consumer. The warranty period applies to the following components:

Home Use WARRANTY

	<u>ET6</u>	<u>ET8 /ET10</u>
Drive Motor	30 Years	30 years
Parts	3 Years	5 years
Frame and Deck	Lifetime	Lifetime
Labor	1 Year	1 year

NORMAL RESPONSIBILITIES OF THE CONSUMER

This warranty applies only to products in ordinary household use or light Institutional facility. The consumer is responsible for the items listed below:

1. The warranty registration card must be completed and returned to the address listed on the card within 10 days of the original purchase to validate the manufacturer's limited warranty.
2. Proper use of the treadmill in accordance with the instructions provided in this manual, including belt tracking.
3. Proper installation by an authorized Spirit service company in accordance with instructions provided with the treadmill and with all local electric codes.
4. Proper connection to a grounded power supply of sufficient voltage, replacement of blown fuses, repair of loose connections or defects in house wiring.
5. Expenses for making the treadmill accessible for servicing, including any item that was not part of the treadmill at the time it was shipped from the factory.
6. Damages to the treadmill finish during shipping, installation or following installation.

EXCLUSIONS

This warranty does not cover the following:

1. CONSEQUENTIAL, COLLATERAL, OR INCIDENTAL DAMAGES SUCH AS PROPERTY DAMAGE AND INCIDENTAL EXPENSES RESULTING FROM ANY BREACH OF THIS WRITTEN OR ANY IMPLIED WARRANTY.

Note: Some states do not allow the exclusion or limitation of incidental or consequential damages, so this limitation or exclusion may not apply to you.

2. Service call reimbursement to the consumer. Service call reimbursement to the dealer that does not involve malfunction or defects in workmanship or material, for units that are beyond the warranty period, for units that are beyond the service call reimbursement period, for treadmills not requiring component replacement, or treadmills not in ordinary household use.
3. Damages caused by services performed by persons other than authorized Spirit service companies; use of parts other than original Spirit parts; or external causes such as alterations, modifications, abuse, misuse, accident, improper maintenance, inadequate power supply, or acts of God.
4. Products with original serial numbers that have been removed or altered.
5. Products that have been sold, transferred, bartered, or given to a third party.
6. Products that do not have a warranty registration card on file at Spirit Mfg. Spirit reserves the right to request proof of purchase if no warranty record exists for the product.
7. THIS WARRANTY IS EXPRESSLY IN LIEU OF ALL OTHER WARRANTIES EXPRESSED OR IMPLIED, INCLUDING THE WARRANTIES OF MERCHANTABILITY AND/OR FITNESS FOR A PARTICULAR PURPOSE.

SERVICE

Keep your bill of sale. Twelve (12) months from the date on the bill of sale or eighteen (18) months from the date of factory shipping as determined by the serial number establishes the warranty period should service be required. If service is performed, it is in your best interest to obtain and keep all receipts. This written warranty gives you specific legal rights. You may also have other rights that vary from state to state. Service under this warranty must be obtained by following these steps, in order:

1. Contact your selling authorized Spirit dealer. OR
2. Contact your local authorized Spirit service organization.
3. If there is a question as to where to obtain service, contact our service department at (870) 935-1107.
4. If no local service is available, Spirit will repair or replace the parts, at Spirit's option, within the warranty period at no charge for parts. All transportation costs, both to our factory and upon return to the owner, are the responsibility of the owner. The owner is responsible for adequate packaging upon return to Spirit. Spirit is not responsible for damages in shipping. Make all freight damage claims with the appropriate freight carrier. DO NOT SHIP ANY UNIT TO OUR FACTORY WITHOUT A RETURN AUTHORIZATION NUMBER. All units arriving without a return authorization number will be refused.
5. For any further information, or to contact our service department by mail, send your correspondence to:

Spirit Manufacturing, Inc.
P.O. Box 2037
Jonesboro, AR 72402-2037

Product features or specifications as described or illustrated are subject to change without notice. All warranties are made by Spirit Manufacturing, Inc. This warranty applies only in the 50 states of the U.S.A.