

SPIRIT



*EL7
Elliptical*

OWNER'S MANUAL

***PLEASE CAREFULLY READ THIS ENTIRE MANUAL BEFORE
OPERATING YOUR NEW ELLIPTICAL!***

Table of Contents

Product Registration.....	2
Important Safety Instructions.....	3
Important Electrical Information.....	4
Important Operation Instructions.....	4
Assembly Instructions.....	5
Operation of Your New Elliptical.....	15
Manufacturer's Limited Warranty.....	27

SPIRIT

**CONGRATULATIONS ON YOUR
NEW ELLIPTICAL AND WELCOME
TO THE SPIRIT FAMILY!**

Thank you for your purchase of this quality elliptical trainer from Spirit Manufacturing, Inc. Your new elliptical was manufactured by one of the leading fitness manufacturers in the world and is backed by one of the most comprehensive warranties available. Through your dealer, Spirit will do all we can to make your ownership experience as pleasant as possible for many years to come. The local dealership where you purchased this elliptical is your administrator for all Spirit warranty and service needs. Their responsibility is to provide you with the technical knowledge and service personnel to make your experience more informed and any difficulties easier to remedy.

Please take a moment at this time to record the name of the dealer, their telephone number, and the date of purchase below to make any future, needed contact easy. We appreciate your support and we will always remember that you are the reason that we are in business. Please complete and mail your registration card today and enjoy your new elliptical.

Yours in Health,
Spirit Manufacturing, Inc.

Name of Dealer _____
Telephone Number of Dealer _____
Purchase Date _____

Product Registration

RECORD YOUR SERIAL NUMBER

Please record the Serial Number of this fitness product in the space provided below.

Serial Number _____

REGISTER YOUR PURCHASE

The self-addressed product registration card must be completed in full and returned to Spirit Manufacturing, Inc or visit: www.spiritfitness.com/warranty.htm to register online.

EL7 ver. A

Important Safety Instructions

DANGER - To reduce the risk of electric shock disconnect your elliptical from the electrical outlet prior to cleaning and/or service work.

WARNING - To reduce the risk of burns, fire, electric shock, or injury to persons, install the elliptical on a flat level surface with access to a nominal 110-volt, 15-amp grounded outlet with only the elliptical plugged into the circuit..

DO NOT USE AN EXTENSION CORD UNLESS IT IS A 14AWG OR BETTER, WITH ONLY ONE OUTLET ON THE END: DO NOT ATTEMPT TO DISABLE THE GROUNDED PLUG BY USING IMPROPER ADAPTERS, OR IN ANY WAY MODIFY THE CORD SET. A serious shock or fire hazard may result along with computer malfunctions. See Grounding Instructions, page 4.

- Do not operate elliptical on deeply padded, plush or shag carpet. Damage to both the carpet and elliptical may result.
- Keep children away from the elliptical. There are obvious pinch points, moving parts and other caution areas that can cause harm.
- Keep hands away from all moving parts.
- Never operate the elliptical if it has a damaged cord or plug. If the elliptical is not working properly, call your dealer.
- Keep the cord away from heated surfaces.
- Do not operate where aerosol spray products are being used or where oxygen is being administered. Sparks from the motor could ignite a highly gaseous environment
- Never drop or insert any object into any openings.
- Do not use outdoors.
- To disconnect, turn all controls to the off position, then remove the plug from the outlet.
- Do not attempt to use your elliptical for any purpose other than for the purpose it is intended.
- The hand pulse sensors are not medical devices. Various factors, including the user's movement, may affect the accuracy of heart rate readings. The pulse sensors are intended only as exercise aids in determining heart rate trends in general.
- Wear proper shoes. High heels, dress shoes, sandals or bare feet are not suitable for use on your elliptical. Quality athletic shoes are recommended to avoid leg fatigue.

Important Electrical Information

WARNING!

- **NEVER** remove any cover without first disconnecting AC power supply.
- If A.C. voltage varies by ten percent (10%) or more, the performance of your elliptical may be affected. **Such conditions are not covered under your warranty.** If you suspect the voltage is low, contact your local power company or a licensed electrician for proper testing.
- **NEVER** expose this elliptical to rain or moisture. This product is **NOT** designed for Use outdoors, near a pool or spa, or in any other high humidity environment. The operating temperature specification is 40 to 120 degrees Fahrenheit and humidity limit is 95%, non-condensing (no water drops forming on surfaces).

Important Operation Instructions

- **NEVER** operate this elliptical without reading and completely understanding the results of any operational change you request from the computer.
- Understand that changes in resistance do not occur immediately. Set your desired level on the computer console and release the adjustment key. The computer will obey the command gradually.
- **NEVER** use your elliptical during an electrical storm. Surges may occur in your household power supply that could damage elliptical components. Unplug the elliptical during an electrical storm as a precaution.
- Use caution while participating in other activities while using your elliptical such as watching television, reading, etc. These distractions may cause you to lose balance, and that may result in serious injury.
- Always hold on to a handrail or hand bar while making control changes.

Do not use excessive pressure on console control keys. They are precision set to properly function with little finger pressure. Pushing harder is not going to make the unit go faster or slower. If you feel the buttons are not functioning properly with normal pressure, contact your Spirit dealer.

Grounding Instructions

This product must be grounded. If the electrical system of the elliptical should malfunction or breakdown grounding provides a path of least resistance for electric current; reducing the risk of electric shock. This product is equipped with a cord having an equipment-grounding plug. The plug must be plugged into an appropriate outlet that is properly installed and grounded in accordance with all local codes and ordinances.

DANGER - Improper connection of the equipment-grounding conductor can result in a risk of electric shock. Check with a qualified electrician or serviceman if you are in doubt as to whether the product is properly grounded. Do not modify the plug provided with the product if it will not fit the outlet; have a proper outlet installed by a qualified electrician.

This product is for use on a nominal 110-volt circuit, and has a grounding plug that looks like the plug illustrated below. A temporary adapter that looks like the adapter illustrated below may be used to connect this plug to a 2-pole receptacle as shown below if a properly grounded outlet is not available. The temporary adapter should be used only until a properly grounded outlet, (shown below) can be installed by a qualified electrician. The green colored rigid ear-lug, or the like, extending from the adapter, must be connected to a permanent ground such as a properly grounded outlet box cover. Whenever the adapter is used, it must be held in place by a metal screw.

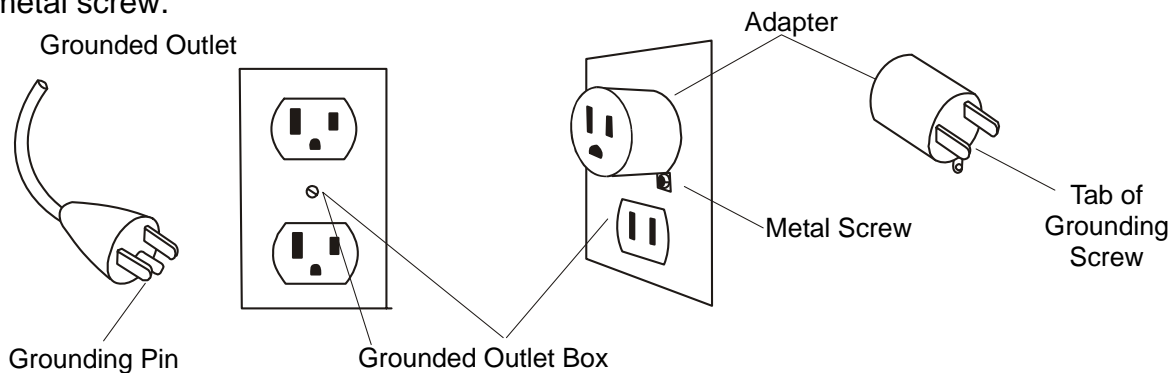

Assembly Pack Check List

Step 1

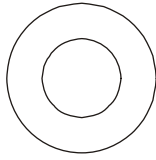

#96. 3/8" x 19 x 1.5T
Flat Washer (2pcs)

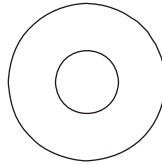

#100. 5/16" x 20x 1.5T
Flat Washer (4 pcs)

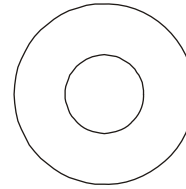

#104. 3/8" x 23 x 2T
Curved Washer (2pcs)

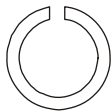

#128. 3/8" x 2T
Split Washer (1pc)

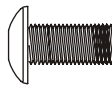

#85. M5x10m/m
Phillips Head Screw (4 pcs)



#89. 3/8" x 7T
Nylon Nut (2 pcs)



#178. Ø5/16" x 1.5T
Split Washer (4pcs)

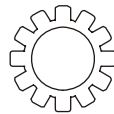

#179. Ø5/16"
Star Washer (4pcs)

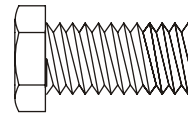

#76. 3/8" x 3/4"
Hex Head Bolt (2pcs)

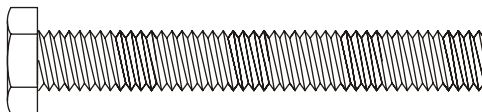

#167. 5/16" x 2-1/4"
Hex Head Bolt (4 pcs)

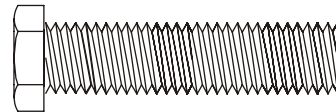

#77. 3/8" x 1-1/2"
Hex Head Bolt (2pcs)

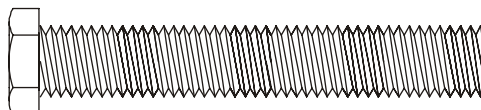

#75. 3/8" x 2-1/4"
Hex Head Bolt (1pc)

Step 2

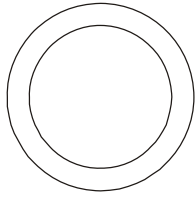

#102. 25 m/m
Wave Washer (2 pcs)

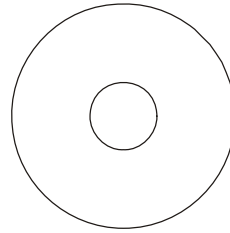

#131. 3/8" x 30 x 2.0T
Flat Washer (2 pcs)

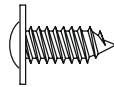

#107. Ø3.5x12m/m
Sheet Metal Screw (6 pcs)

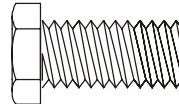

#76. 3/8" x 3/4"
Hex Head Bolt (2pcs)

Step 3

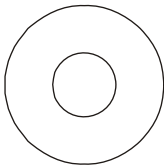

#100. 5/16" x 20 x 1.5T
Flat Washer (2 pcs)



#91. 5/16" x 7T
Nylon Nut (2 pcs)

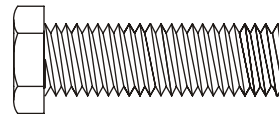

#79. 5/16" x 1-1/4"
Hex Head Bolt (2 pcs)

Step 4

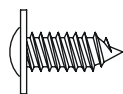

#107. 3.5x12m/m
Sheet Metal Screw (2pcs)

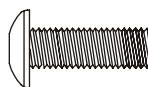

#82. M5 x 15m/m
Phillips Head Screw (22pcs)

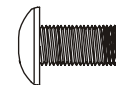

#157. M6 x 10m/m
Phillips Head Screw (4 pcs)

Tools

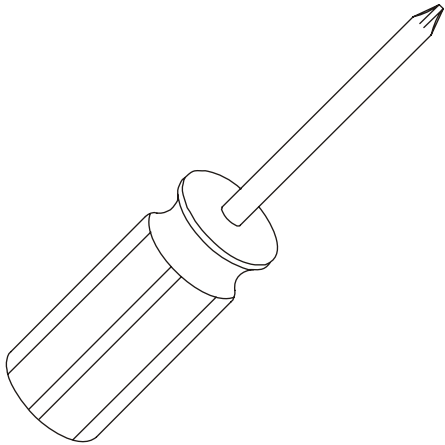

#126. Phillips Screw Driver (1 pc)

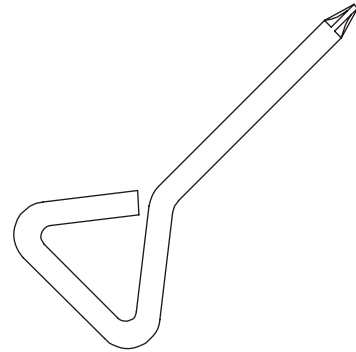

#125. Short Phillips Screw Driver (1 pc)

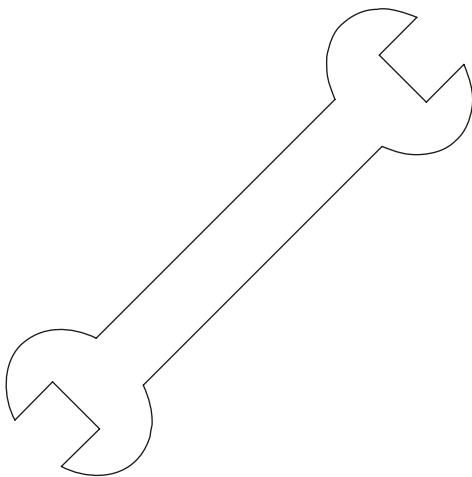

#129. 12 / 14 m/m Wrench (1 pc)

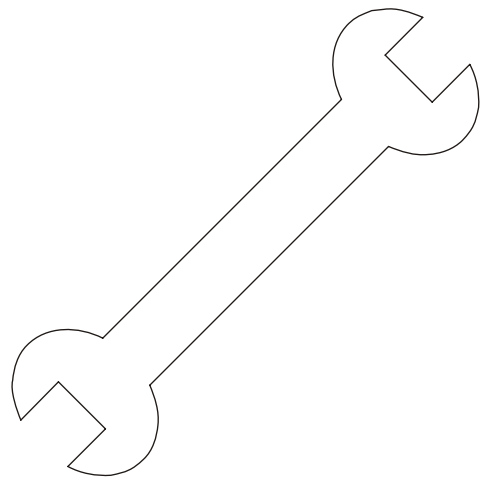

#124. 13 / 14m/m Wrench (1 pc)

Assembly Instructions

■ UNPACKING THE UNIT

1. Using a razor knife (Box Cutter) cut the outside, bottom, edge of box along the dotted Line. Lift Box over the unit and unpack.
2. Carefully remove all parts from carton and inspect for any damage or missing parts. If damaged parts are found, or parts are missing, contact your dealer immediately.
3. Locate the hardware package. The hardware is separated into steps. Remove the tools first. Remove the hardware for each step as needed to avoid confusion. The numbers in the instructions that are in parenthesis (#) are the item number from the assembly drawing, for reference.

STEP 1: Incline Rail Assembly and Console Mast

1. Install the Incline Rail Assembly (2) into the U-channel bracket of the Main Frame (1). Secure with the six bolts & associated hardware as follows: From the sides install two 3/8"x1-1/2" Hex Head Bolts (77) with two 3/8"x19mm Flat Washers (96) and two 3/8"x7T Nylon Nuts (89). From the top install four 5/16"x2-1/4" Hex Head Bolts (167), four 5/16" Split Washers (178), four 5/16"x20 Flat Washers (100), and four 5/16" Star Washers (179), as shown in figure 1, and tighten with the 13/14 mm Wrench (124) and 12/14mm Wrench (129).
2. Connect the three Incline Motor Power lines by matching the Red, White and Black color codes of the wires (37) and the 3-pin position Sensor Connector (38). Locate the Console Mast (12) and Console Mast Cover (49) and slide the Cover onto the Mast as far as it will go. Make sure the Console Mast Cover is facing the correct way. At the top opening of the Main Frame of the elliptical there is a Computer Cable (39) and an incline cable (36). Unravel and straighten out the cables and feed them into the bottom of the console mast tube and out of the top opening. Install the Console Mast (12) into the receiving bracket on the top of the Main Frame (1). Pull slightly on the cables at the top of the mast while installing. This will ensure the cable does not get pinched and electrically shorted during the console mast assembly.
3. Put one 3/8" x 2T Split Washer (128) onto the 3/8" x 2-1/4" Long Hex Head Bolt (75) and install through the left side of the receiving bracket into the Console Mast (12). Put the two 3/8" x 23 Curved Washers (104) onto the two 3/8" x 3/4" Short Hex Head Bolts (76) and install through the front of the console mast. Using the 13/14m/m Wrench, tighten the three bolts, and the fourth bolt, which is pre-installed, firmly. These bolts should be tightened as much as you possibly can.
4. Plug all of the connectors into the back of the console; Computer Cable (39), two Hand pulse Cables (44) and Incline cable (36). Secure the Console (32) on the console mounting plate with four M5x10m/m Phillips Head Screws (85).

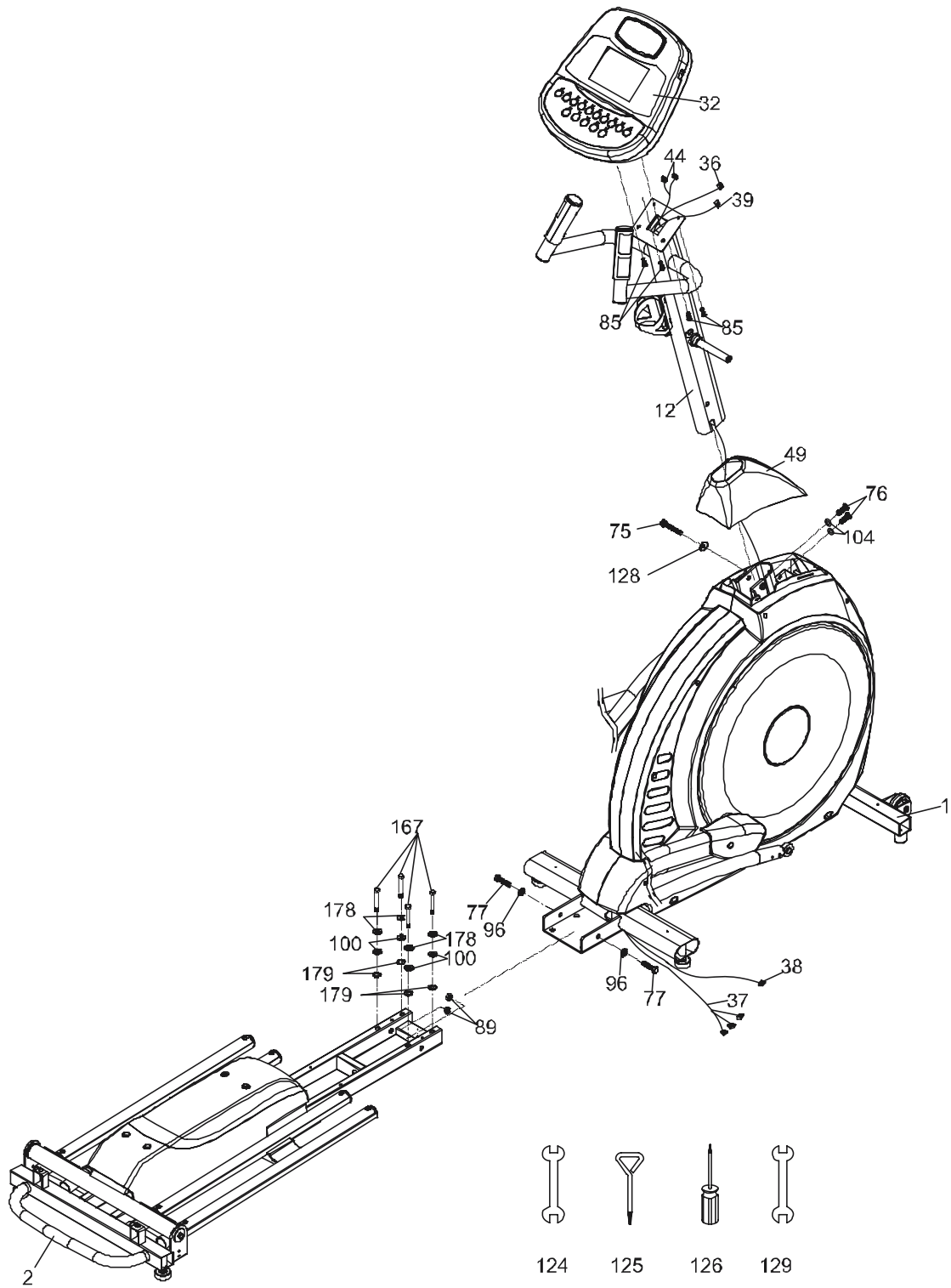

STEP 2: HANDLE BAR ASSEMBLY

1. Install the two 25mm Wave Washers (102) onto the Left and Right side of the Handle Bar axle.
2. Slide the Left (10) and Right (11) Handle Bars onto the appropriate side of the axle. The handlebars have a small sticker on them indicating **L** (left) and **R** (right).
3. Install two 3/8" X 35 mm Flat Washers (131) onto the two 3/8" X 3/4" Hex Head Bolts (76) and install, and tighten, in the threaded holes in the ends of the axle.
4. Install the Front Handle Bar Covers (68 left, 69 right) and Rear Handle Bar Covers (68-1 left, 69-1 right) over the Handle Bar axle connections and secure with the six 3.5x10mm Sheet Metal Screws (107).

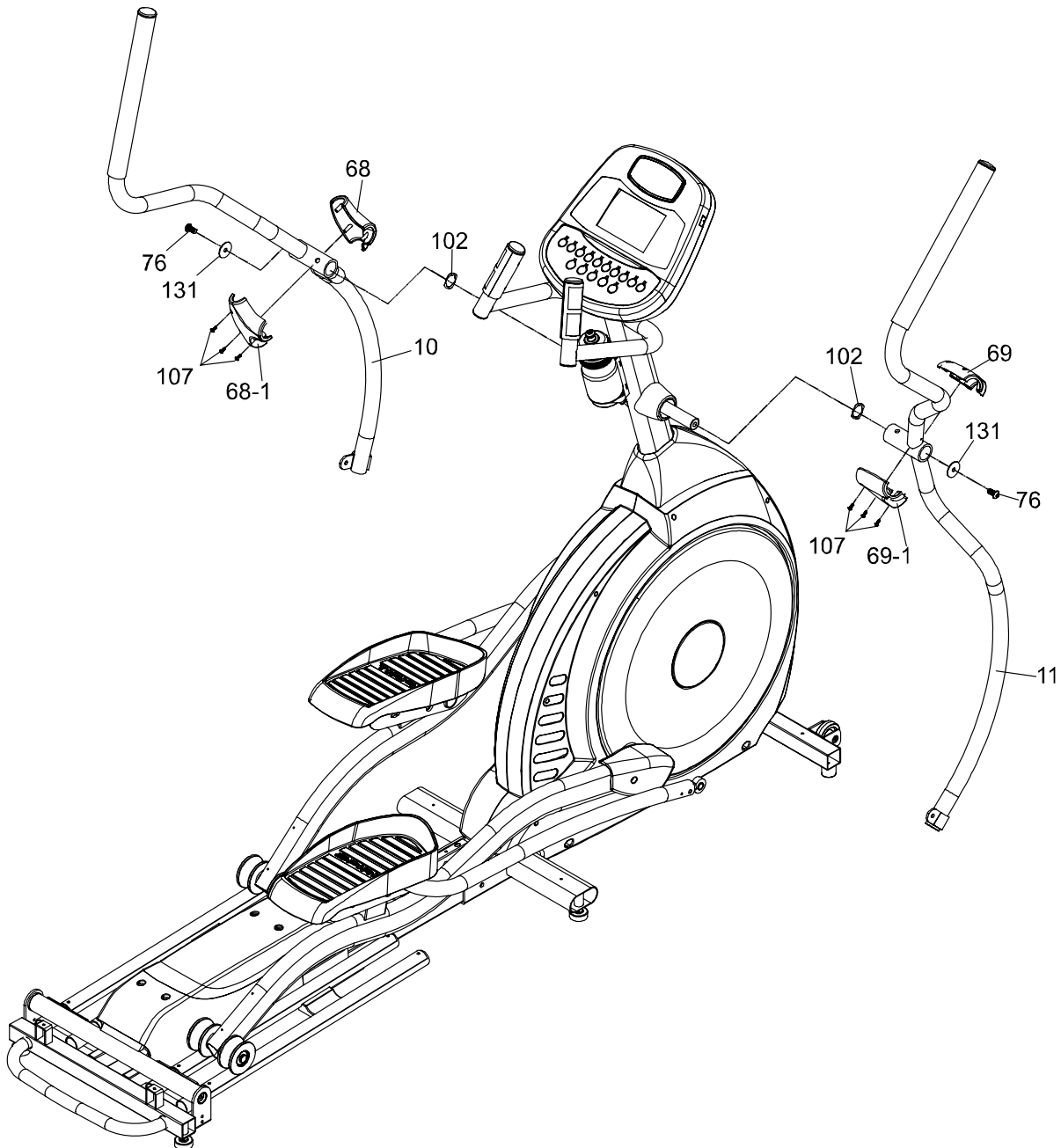

STEP 3: CONNECTING ARM ASSEMBLY

Untie the wire holding the Sleeve Spacer (22) in place on the rod-end bearings located on the ends of the connecting arms (8&9). Align the hole in the rod ends with the hole in the brackets of the left and right Handle Bar (10&11). The rod end should be on the inside of the Handle Bar bracket. Secure both sides with a 5/16"x1-1/4" Hex Head Bolt (79), 5/16"x20mm Flat Washer (100) and 5/16" Nylon Nut (91) by using 13/14 mm Wrench (124) and 12/14 mm Wrench (129).

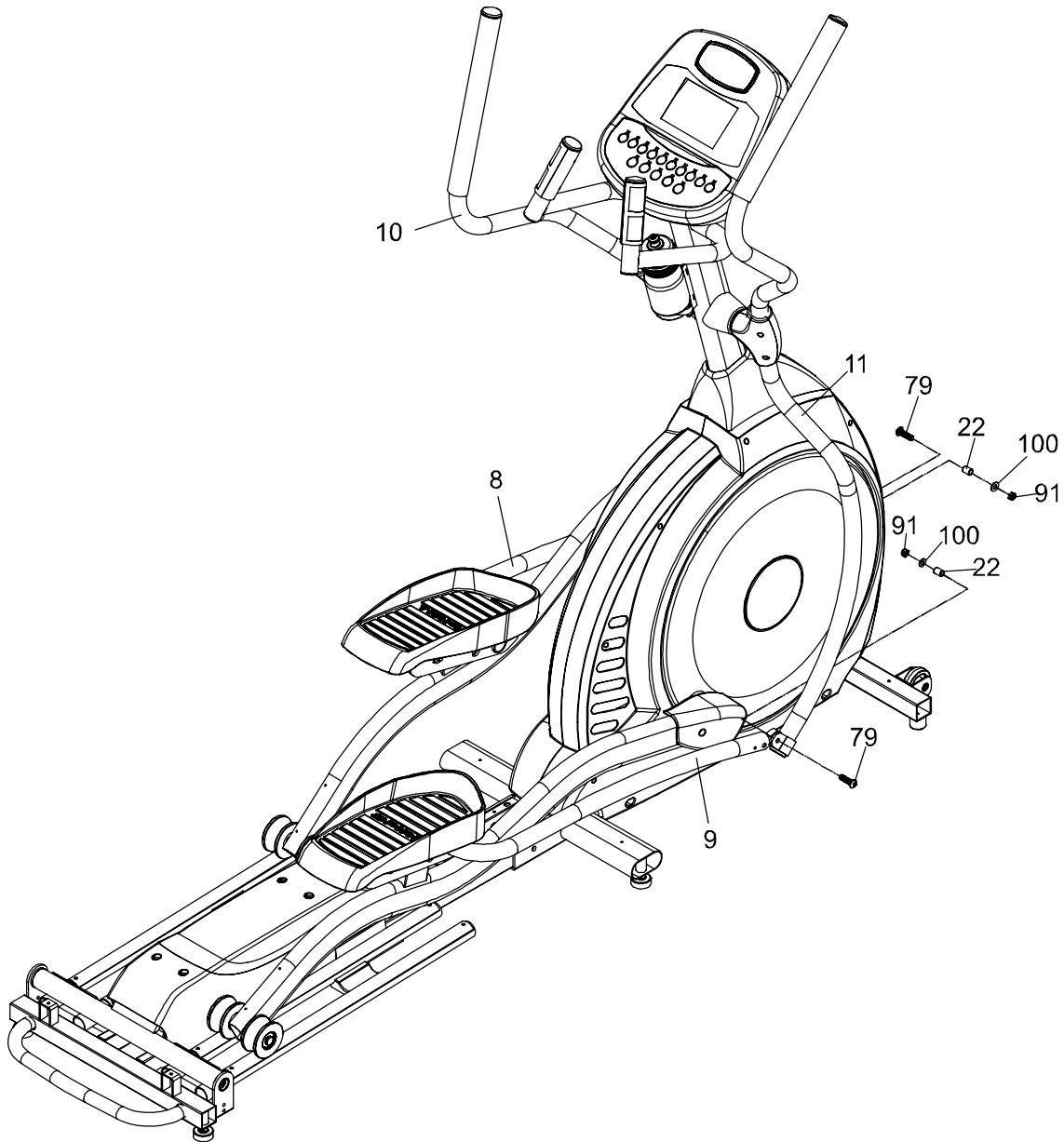

STEP 4: PLASTICS ASSEMBLY

1. Match up the Connecting Arm Covers (71 and 72) and install onto the Left and Right Connecting Arms (8&9) and secure each side with two M5x15mm Phillips Head Screws (82) and one 3.5x12mm Sheet Metal Screws (107) by using Short Phillips Head Screw Driver (125).
2. Install Sliding Wheel Covers (64) on each side and secure with four M5x15mm Phillips Head Screws (82).
3. Install the two Stabilizer Covers (60 and 61) on the middle stabilizer bar with two M5x15mm Phillips Head Screws (82).
4. Install the Front Stabilizer Cover (59) on the front stabilizer with two M5x15mm Phillips Head Screws (82).
5. Install the two Incline Cover brackets (156), with the hole for mounting the plastic cover on the bent tab facing rearward, and secure them on the Incline Rail Assembly (2) with four M6x10mm Phillips Head Screws (157). Install the Rear Incline bar cover (73-2) on the rail base with two M5 x 15mm/m Screws (82).
6. Install the Rear Stabilizer Cover (73-3) on the Rear Stabilizer with four M5x15mm Phillips Head Screws (82).
7. ***This step to be performed after the elliptical power is plugged in.** Run the incline to position 8 and install the Incline Rail front cover (73) up against the middle stabilizer tube with four M5x15mm Phillips Head Screws (82).

PLEASE ENSURE ALL THE FASTENERS ARE TIGHT AFTER ALL THE ASSEMBLY STEPS HAVE BEEN COMPLETED.

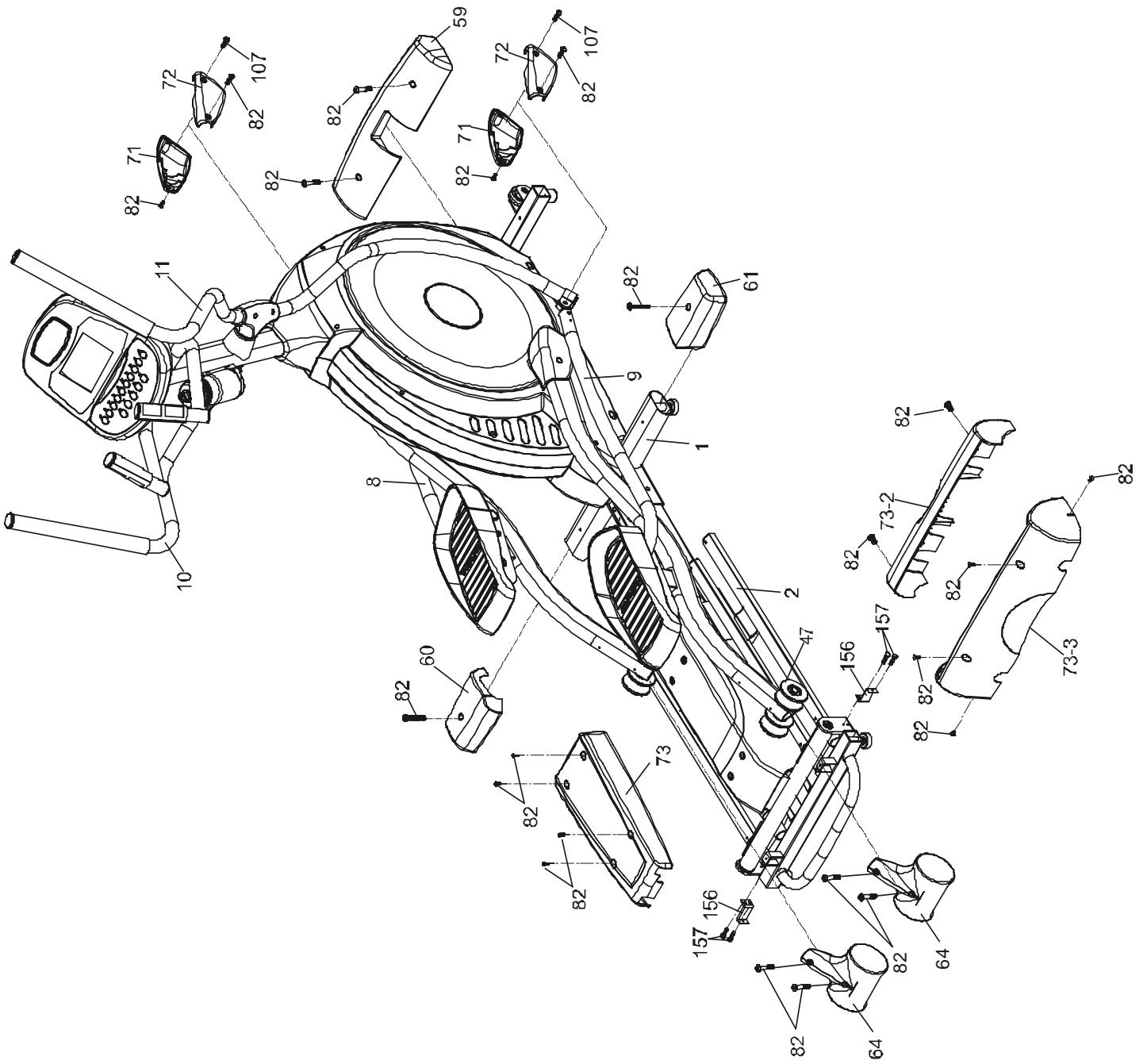

Features

Adjustable foot pedals, and correctly aligned orthopedic foot pads

Through research performed with a leading sports scientist and physical rehabilitation expert; Spirit engineering has developed a breakthrough in pedal design. No other elliptical, at any price, offers these unique features. The history of elliptical use over the past few years tells us that many users suffer from numb toes while working out on elliptical trainers. Many other users complain of ankle, Achilles tendon, knee and/or hip pain. While researching a solution to these common problems Spirit engineers consulted Richard DeKok, P.T., M.T.C., of St. Bernard's Industrial Rehabilitation Center in Jonesboro Arkansas. Together we identified the inherent problem in elliptical designs and developed solutions to solve the problems. What we found is that when you use an elliptical you tend to push outward during the power stroke and not just straight back. This causes stress on the outer part of the foot and throws off the natural alignment of the joints. The second problem we found is that many people tend to stay up on the ball of their foot during the elliptical motion. Our solutions were simple but effective:

- The first solution was to add a 2-degree inward angle to the footpads. This might sound simple but what it does is puts the users joints back into a neutral alignment. This eases the over stressing of the ankles, knees and hips.
The second solution was to make the foot pedal adjustable to the user's style of pedaling the elliptical. We achieved this by adding an adjustment that allows the angle of the footpad to be changed. Because everybody is different, and there are as many styles to pedal an elliptical as there are people, we found there is no one angle that fit every user. Some users would be up on the balls of their feet, resulting in numb toes, so we decided to let the user adjust the back of the foot pad upward to support the heel, taking the pressure off of the nerves in the balls of the feet and the Achilles tendon. The result was no more numb toes. Some users are uncomfortable at this angle so for them we designed in three different adjustable angles so they could find one that feels best for them.
- There are three footpad angle settings available by pulling on the red quick release handle under the rear of each footpad. The lowest setting will set the footpads at zero (0) degrees, or flat, at the bottom of the elliptical stroke. The second position sets the footpad to five (5) degrees and the top position sets the footpads to ten (10) degrees.

Ramp incline adjustment

The Esprit EL7 now has an exciting new ramp incline feature that will further increase the variety of your workouts. When the incline is at its lowest position you get a normal elliptical workout. As the incline increases you will feel your knees rise higher with each step; which means you are involving more muscle groups. The power incline is controlled by buttons on the console and also automatically controlled during the built-in workout programs.

Operation of Your Elliptical

Getting familiar with the control panel

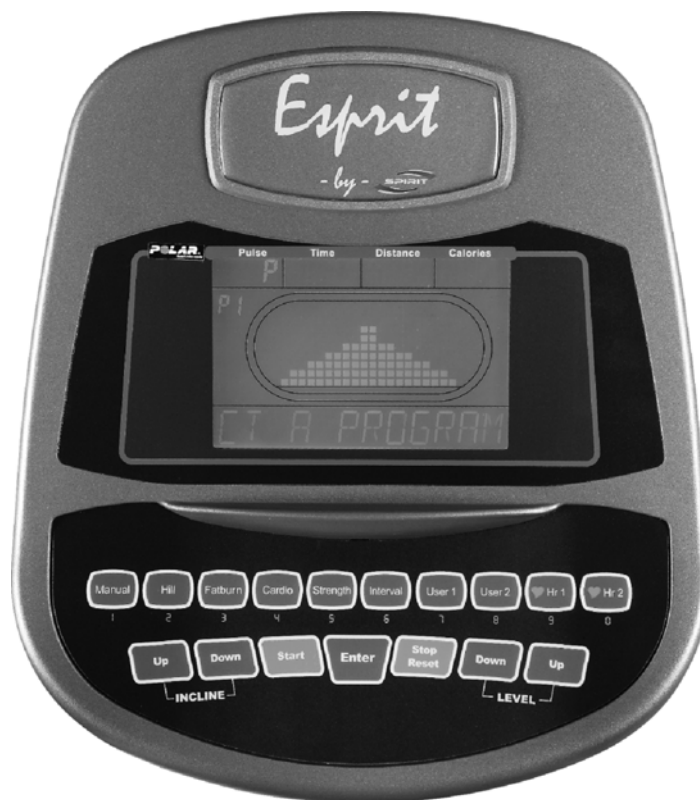

Power up

The Elliptical is supplied with an external power supply. When power is connected to the Elliptical, the console will automatically power up. If there is no input to the console for 20 minutes the console will go to stand-by mode. In stand-by mode the console display will turn off. To turn the console on press any key.

When initially powered on the console will perform an internal self-test. During this time all the lights will turn on. When the lights go off the dot matrix display will show a software version (i.e.: VER 1.0) and the message window will display an odometer reading. The odometer reading displays how many hours the elliptical has been used and how many virtual miles the elliptical has gone. The time in hours will be to the left and the odometer in miles will be displayed to the right.

The odometer will remain displayed for only a few seconds, then the console will go to the start up display. The dot matrix display will be scrolling through the different workout profiles of the programs and the message window will be scrolling the start up message. You may now begin to use the console.

Console Operation

Quick Start

This is the quickest way to start a workout. After the console powers up you just press the Start key to begin, this will initiate the Quick Start mode. In Quick Start the Time will count up from zero and the workload and Incline may be adjusted manually by pressing the Up or Down buttons. The dot matrix display will have only the bottom row lit at first. As you increase the work load more rows will light indicating a harder workout. The elliptical will get harder to pedal as the rows increase. When you press the Incline buttons, the dot matrix display will switch to show the incline profile. There will also be an icon showing the word "Incline" just above the profile. To switch back to view the work profile, press the up or down workload keys.

Basic information

The **Message Window** will initially be displaying **Speed** information in Miles Per Hour (MPH). Each time the **Enter** button is pressed the next set of information will appear, five sets of data in all.

- **Speed** in Miles Per Hour (MPH)
- **Speed** in RPM (Revolutions Per Minute). This is the actual pedal speed.
- "L" (Current Work Level) and "MaxL" (Maximum Work Level of the program)
- **Watts** Indication of workload. If 100 watts is displayed, you are doing enough work to keep a 100-watt light bulb lit.
- **Ramp** Shows incline level from 1 to 20. The dot matrix will switch to the incline profile at the same time
- **Scan** the message window will show each set of data for four seconds then switch to the next set of data in a continuous loop. Pressing the Enter button again will bring you back to the beginning.

The **Stop/Reset** button actually has several functions. Pressing the Stop/Reset key once during a program will **Pause** the program for 5 minutes. If you need to get a drink, answer the phone or any of the many things that could interrupt your workout, this is a great feature. To resume your workout during Pause, just press the Start key. If the Stop/Reset button is pressed twice during a workout the program will end and the console will return to the start up screen. If the Stop/Reset key is held down for 5 seconds the console will perform a complete **Reset**. During data entry for a program the Stop/Reset key performs a **Previous Screen** function. This allows you to go back one step in the programming each time you press the Stop/Reset key.

Program Keys:

The program keys perform three different functions:

The **Program Keys** are used to preview each program. When you first turn the console on you may press each program key to preview what the program profile looks like. If you decide that you want to try a program, press the corresponding program key and then press the Enter key to select the program and enter into the data-setting mode.

The program keys also act as a **Numeric Key Pad** when you are in the data-setting mode. Under each program key is a number. If you are setting new data, such as Age, weight etc., you can use these keys to enter the numbers quickly.

Finally, the program keys can be used as "**Quick keys**" for workload and incline settings anytime after the Start key is pressed. The 5 keys on the left are for incline settings and the 5 keys on the right are for workload settings. When pressed, the Quick keys will allow you to jump directly to an incline position or workload setting of 3, 6, 9, 12 or 15 instantly. This function is not shown on the front panel so you need to try it out yourself to become familiar with its operation

The Elliptical has a built in heart rate monitoring system. Simply grasping the hand pulse sensors on the stationary handle bars, or wearing the Polar heart rate transmitter, will start the **Heart Icon** blinking (this may take a few seconds). The Pulse Display Window will display your heart rate, or Pulse, in beats per minute.

Programming the console

Each of the programs can be customized with your personal information and changed to suit your needs. Some of the information asked for is necessary to ensure the readouts are correct. You will be asked for your **Age** and **Weight**. Entering your **Age** is necessary during the Heart Rate control programs to ensure the correct settings are in the program for your Age. Otherwise the work settings could be too high or low for you. Entering your weight aids in calculating a more correct calorie reading. Although we cannot provide an exact calorie count we do want to be as close as possible.

A message about Calories: Calorie readings on every piece of exercise equipment, whether it is in a gym or at home, are not accurate and tend to vary widely. They are meant only as a guide to monitor your progress from workout to workout. The only way to measure your calorie burn accurately is in a clinical setting connected to a host of machines. This is because every person is different and burns calories at a different rate. Some good news is that you will continue to burn calories at an accelerated rate for at least an hour after you have finished exercising!

Entering/Changing Settings

When you enter a program, by pressing a program key, then enter key, you have the option of entering your own personal settings. If you want to workout without entering new settings then just press the Start key. This will bypass the programming of data and take you directly to the start of your workout. If you want to change the personal settings then just follow the instructions in the message window. If you start a program without changing the settings the default, or saved, settings will be used.

NOTE: Age and Weight default settings will change when you enter a new number. So the last Age and Weight entered will be saved as the new default settings. If you enter your Age and Weight the first time you use the Elliptical you will not have to enter it every time you work out unless either your Age or Weight changes or someone else enters a different Age and Weight.

Manual

The Manual program works as the name implies, manually. This means that you control the workload yourself and not the computer. To start the Manual program follow the instructions below or just press the Manual button then the Enter button and follow the directions in the message window.

1. Press the **Manual** key then press the **Enter** key.
2. The message window will ask you to enter your **Age**. You may enter your Age, using the Up and Down keys or the numeric key pad, then press the Enter key to accept the new number and proceed on to the next screen.
3. You are now asked to enter your **Weight**. You may adjust the Weight number using the Up and Down keys or the numeric key pad, then press enter to continue.
4. Next is **Time**. You may adjust the Time and press enter to continue.
5. Now you are finished editing the settings and can begin your workout by pressing the Start key. You can also go back and modify your settings by pressing the Enter key. NOTE: At any time during the editing of Data you can press the Stop key to go back one level, or screen.
6. Once the program starts you will be at level one. This is the easiest level and it is a good idea to stay at level one for a while to warm up. If you want to increase the work load at any time press the Up key; the Down key will decrease the work-load.
7. During the Manual program you will be able to scroll through the data in the message window by pressing the **Enter key**.
8. When the program ends you may press **Start** to begin the same program again or Stop to exit the program or you can save the program you just completed as a **custom user program** by pressing a User key and following the instructions in the message window.

Preset Programs

The Elliptical has five different programs that have been designed for a variety of workouts. These five programs have factory preset workload and incline profiles for achieving different goals.

HILL

The **Hill** program simulates going up and down a hill. The resistance in the pedals will steadily increase and then decrease during the program.

Work Profile

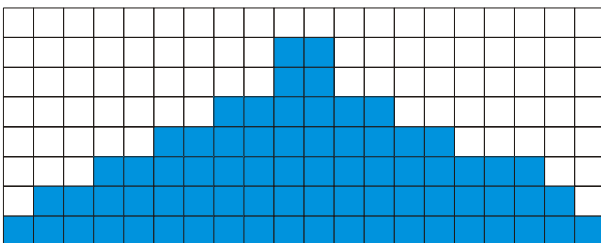

Incline Profile

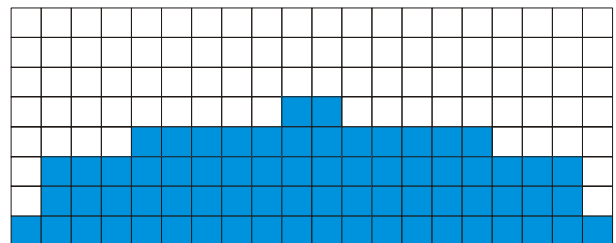

Fat Burn

The **Fat Burn** program is designed, as the name implies, to maximize the burning of fat. There are many schools of thought on the best way to burn fat but most experts agree that a lower exertion level that stays at a steady workload is the best. The absolute best way to burn fat is to keep your heart rate at around 60% to 70% of its maximum potential. This program does not use heart rate but simulates a lower, steady exertion workout.

Work Profile

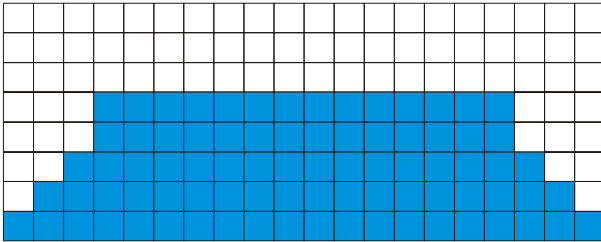

Incline Profile

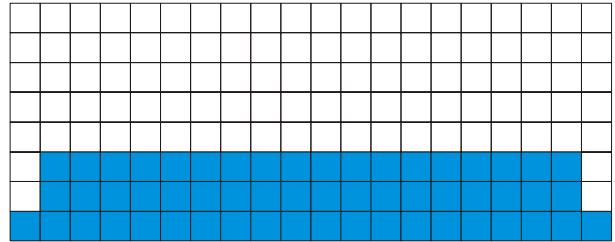

Cardio

The **Cardio** program is designed to increase your Cardio vascular function. This is exercise for your heart and lungs. It will build up your heart muscle and increase blood flow and lung capacity. This is achieved by incorporating a higher level of exertion with slight fluctuations in work.

Work Profile

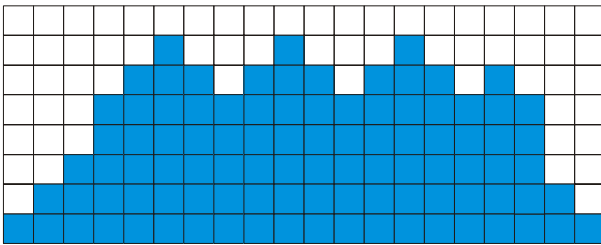

Incline Profile

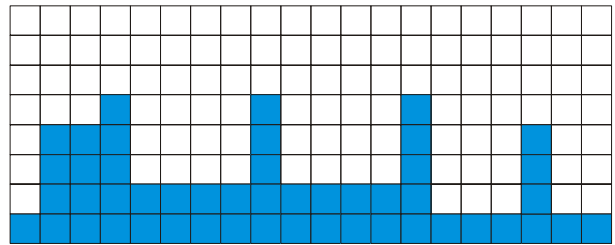

Strength

The **Strength** program is designed to increase muscular strength in your lower body. This program will steadily increase in resistance to a high level and then keeps you there. This is designed to strengthen and tone your legs and glutes.

Work Profile

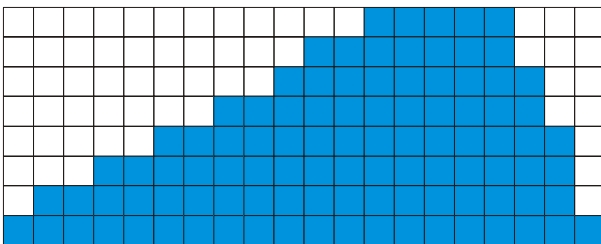

Incline Profile

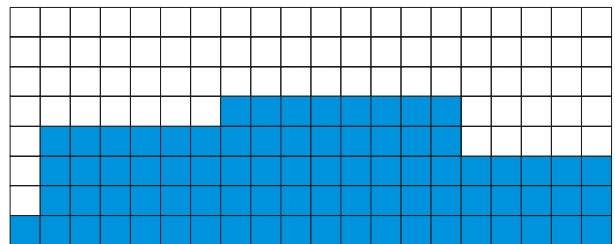

Interval

The **Interval** program takes you through high levels of intensity followed by periods of low intensity. This program increases your endurance by depleting your oxygen level followed by periods of recovery to replenish oxygen. Your cardio vascular system gets programmed to use oxygen more efficiently this way.

Work Profile

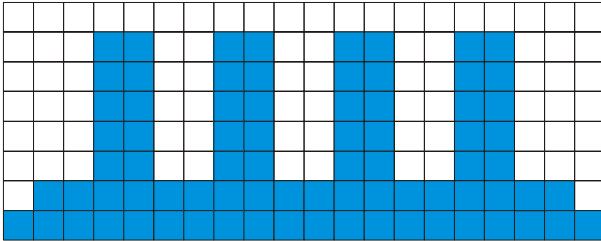

Incline Profile

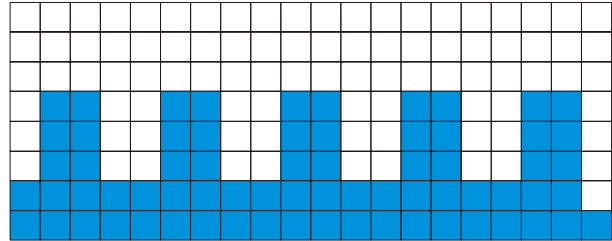

Programming Preset Programs:

1. Select the desired program button then press the **Enter** key.
2. The message window will ask you to enter your **Weight**. You may adjust the weight setting, using the Up and Down keys, then press the Enter key to accept the new number and proceed on to the next screen.
3. You are now asked to enter your **Age**. You may adjust the age number using the Up and Down keys, then press enter to continue.
4. Next is **Time**. You may adjust the Time and press enter to continue.
5. Now you are asked to adjust the **Max Level**. This is the peak exertion level you will experience during the program (at the top of the hill). Adjust the level and then press enter.
6. Next is the option to turn on or off the **Incline profile**. You can choose to turn the incline profile off and just use the Incline switches on the console to manually control the incline angle setting during the program.
7. Now you are finished editing the settings and can begin your workout by pressing the Start key. You can also go back and modify your settings by pressing the Stop key to go back one level, or screen.
8. If you want to increase or decrease the workload at any time during the program press the Up or Down key. This will change the workload settings of the entire profile, although the profile picture on the screen will not change. The reason for this is so that you can see the entire profile at all times. If the profile picture is changed, it also would be distorted and not a true representation of the actual profile. When you make a change to the workload, the message window will show the current column and program maximum levels of work.
9. During the program you will be able to scroll through the data in the message window by pressing the **Enter** key.
10. When the program ends the message window will show a summary of your workout. The summary will be displayed for a short time then the console will return to the start-up display.

Custom User Defined Programs

There are two customizable **User** programs that allow you to build and save your own workout. The two programs, **User 1** and **User 2**, operate exactly the same way so there is no reason to describe them separately. You can build your own custom program by following the instructions below or you can save any other program after you complete it as a custom program. Both programs allow you to further personalize it by adding your name.

1. Press the **User 1** or **User 2** key. The message window will show a welcome message. If you had previously saved a program the message will contain your name. Then press the **Enter** key to begin programming.
2. When you press enter, the message window will show "Name – A", if there is no name saved. If the name "David" had been previously saved the message window will show "Name – David" and the D will be blinking. If there is a name saved you can change it or you may press the Stop key to keep the name and continue to the next step. If you want to enter a new name use the Up and/or the Down key to change the first letter then press Enter to save the first letter and continue to the next letter. When you have finished entering the name press the Stop key to save the name and continue to the next step.
3. The message window will ask you to enter your **Age**. You may enter your Age, using the Up and Down keys or the numeric key pad, then press the Enter key to accept the new number and proceed on to the next screen.
4. You are now asked to enter your **Weight**. You may adjust the Weight number using the Up and Down keys or the numeric key pad, then press enter to continue.
5. Next is **Time**. You may adjust the Time and press enter to continue.
6. Now you are asked to adjust the **Max Level**. This is the peak exertion level you will experience during the program. The factory setting is level seven. Adjust the level and then press enter.
7. Now the first column will be blinking and you are asked to adjust the workload level for the first segment of the workout. When you finish adjusting the first segment, or if you don't want to change, then press enter to continue to the next segment.
8. The next segment will show the same workload level as the previously adjusted segment. Repeat the same process as the last segment then press enter. Continue this process until all twenty segments have been set.
9. The first column will be blinking once more for building an Incline profile. Follow the same procedure as in step 7 & 8 to build the Incline profile.
10. The message window will then tell you to press enter to save the program. After saving the program the message window says "New program saved" then will give you the option to Start or modify the program. Pressing Stop will exit to the start up screen.

Heart Rate programs

Before we get started, a word about Heart Rate:

The old motto, “no pain, no gain”, is a myth that has been overpowered by the benefits of exercising comfortably. A great deal of this success has been promoted by the use of heart rate monitors. With the proper use of a heart rate monitor, many people find that their usual choice of exercise intensity was either too high or too low and exercise is much more enjoyable by maintaining their heart rate in the desired benefit range.

To determine the benefit range in which you wish to train, you must first determine your Maximum Heart Rate. This can be accomplished by using the following formula: 220 minus your age. This will give you the Maximum heart rate (MHR) for someone of your age. To determine the effective heart rate range for specific goals you simply calculate a percentage your MHR. Your Heart rate training zone is 50% to 90% of your maximum heart rate. 60% of your MHR is the zone that burns fat while 80% is for strengthening the cardio vascular system. This 60% to 80% is the zone to stay in for maximum benefit.

For someone who is 40 years old their target heart rate zone is calculated:

$220 - 40 = 180$ (maximum heart rate)
 $180 \times .6 = 108$ beats per minute (60% of maximum)
 $180 \times .8 = 144$ beats per minute (80% of maximum)

So for a 40 year old the training zone would be 108 to 144 beats per minute.

If you enter your age during programming the console will perform this calculation automatically. Entering your age is used for the Heart Rate control programs. After calculating your Maximum Heart Rate you can decide upon which goal you would like to pursue.

The two most popular reasons for, or goals, of exercise are cardiovascular fitness (training for the heart and lungs) and weight control. The black columns on the chart above represent the Maximum Heart Rate for a person whose age is listed at the bottom of each column. The training heart rate, for either cardiovascular fitness or weight loss, is represented by two different lines that cut diagonally through the chart. A definition of the lines' goal is in the bottom left-hand corner of the chart. If your goal is cardiovascular fitness or if it is weight loss, it can be achieved by training at 80% or 60%, respectively, of your Maximum Heart Rate on a schedule approved by your physician. Consult your physician before participating in any exercise program.

With all Esprit Heart Rate Control elliptical machines you may use the heart rate monitor feature without using the Heart Rate Control program. This function can be used during manual mode or during any of the nine different programs. The Heart Rate Control program automatically controls resistance at the pedals.

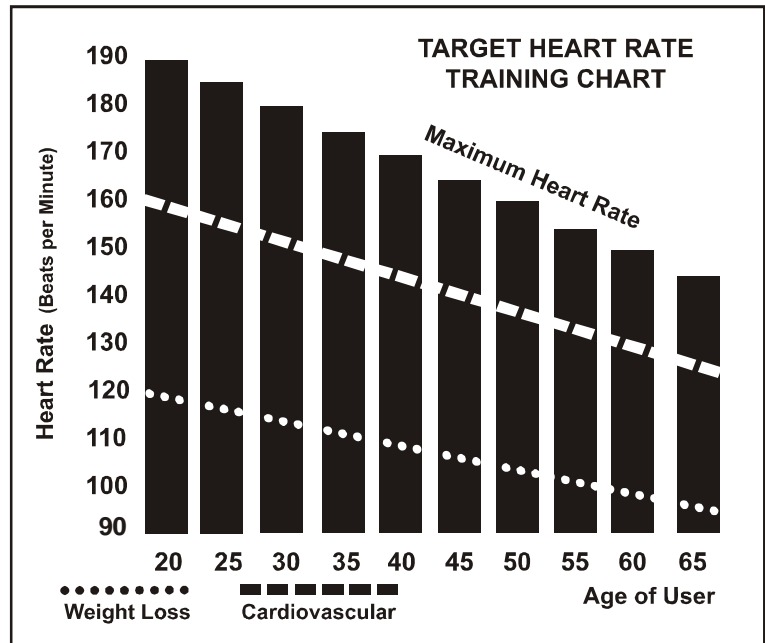

Rate of Perceived Exertion

Heart rate is important but listening to your body also has a lot of advantages. There are more variables involved in how hard you should workout than just heart rate. Your stress level, physical health, emotional health, temperature, humidity, the time of day, the last time you ate and what you ate, all contribute to the intensity at which you should workout. If you listen to your body, it will tell you all of these things.

The rate of perceived exertion (RPE), also know as the Borg scale, was developed by Swedish physiologist G.A.V. Borg. This scale rates exercise intensity from 6 to 20 depending upon how you feel or the perception of your effort.

The scale is as follows:

Rating Perception of Effort

- 6 Minimal
- 7 Very,very light
- 8 Very,very light +
- 9 Very light
- 10 Very light +
- 11 Fairly light
- 12 Comfortable
- 13 Somewhat hard
- 14 Somewhat hard +
- 15 Hard
- 16 Hard +
- 17 Very hard
- 18 Very hard +
- 19 Very,very hard
- 20 Maximal

You can get an approximate heart rate level for each rating by simply adding a zero to each rating. For example a rating of 12 will result in an approximate heart rate of 120 beats per minute. Your RPE will vary depending up the factors discussed earlier. That is the major benefit of this type of training. If your body is strong and rested, you will feel strong and your pace will feel easier. When your body is in this condition, you are able to train harder and the RPE will support this. If you are feeling tired and sluggish, it is because your body needs a break. In this condition, your pace will feel harder. Again, this will show up in your RPE and you will train at the proper level for that day.

Using a Heart Rate Transmitter

How to wear your wireless chest strap transmitter: **(Chest strap transmitter sold separately)**

1. Attach the transmitter to the elastic strap using the locking parts.
2. Adjust the strap as tightly as possible as long as the strap is not too tight to remain comfortable.
3. Position the transmitter with the Polar logo centered in the middle of your body facing away from your chest (some people must position the transmitter slightly left of center). Attach the final end of the elastic strap by inserting the round end and, using the locking parts, secure the transmitter and strap around your chest.
4. Position the transmitter immediately below the pectoral muscles.
5. Sweat is the best conductor to measure very minute heart beat electrical signals. However, plain water can also be used to pre-wet the electrodes (2 black square areas on the reverse side of the belt and either side of transmitter). It's also recommended that you wear the transmitter strap a few minutes before your work out. Some users, because of body chemistry, have a more difficult time in achieving a strong, steady signal at the beginning. After "warming up", this problem lessens. As noted, wearing clothing over the transmitter/strap doesn't affect performance.
6. Your workout must be within range - distance between transmitter/receiver – to achieve a strong steady signal. The length of range may vary somewhat but generally stay close enough to the console to maintain good, strong, reliable readings. Wearing the transmitter immediately against bare skin assures you of proper operation. If you wish, you may wear the transmitter over a shirt. To do so, moisten the areas of the shirt that the electrodes will rest upon.

Erratic Operation:

Caution! Do not use this elliptical for Heart Rate Control unless a steady, solid Actual Heart Rate value is being displayed. High, wild, random numbers being displayed indicate a problem.

Areas to look for interference which may cause erratic heart rate:

- (1) Microwave ovens, TV's, small appliances, etc.
- (2) Fluorescent lights.
- (3) Some household security systems.
- (4) Perimeter fence for a pet.
- (5) Some people have problems with the transmitter picking up a signal from their skin. If you have problems try wearing the transmitter upside down. Normally the transmitter will be oriented so the Polar logo is right side up.
- (6) The antenna that picks up your heart rate is very sensitive. If there is an outside noise source, turning the whole machine 90 degrees may de-tune the interference.
- (7) If you continue to experience problems contact your dealer.

Heart Rate Control Program operation (optional chest strap required)

To start the **HRC** program follow the instructions below or just select the HRC program then the Enter button and follow the directions in the message window.

1. Select the **HRC** program then press the **Enter** key.
2. The message window will ask you to enter your **Weight**. You may enter your weight using the Up and Down keys or the numeric key pad, then press the Enter key to accept the new number and proceed on to the next screen.
3. You are now asked to enter your **Age**. You may adjust the age number using the Up and Down keys or the numeric key pad, then press enter to continue.
4. Next is **Time**. You may adjust the Time and press enter to continue.
5. Now you are asked to adjust the **HRC** percent. The default is 70%; you may select 60% or 80% also. Adjust the level and then press enter.
6. You are now asked to select the Target heart rate Level. This is the heart rate level you will experience during the program. Adjust the level and then press enter.
7. Now you are finished editing the settings and can begin your workout by pressing the Start key. You can also go back and modify your settings by pressing the Stop key to go back one level, or screen.
8. If you want to increase or decrease the workload at any time during the program press the Up or Down key. This will allow you to change your target heart rate at any time during the program.
9. During the HRC program you will be able to scroll through the data in the message window by pressing the adjacent **Display** key.
10. When the program ends the message window will show a summary of your workout. The summary will be displayed for a short time, then the console will return to the start-up display.

Maintenance:

1. Wipe down all areas in the sweat path with a damp cloth after each workout.
2. If a squeak, thump, clicking or rough feeling develops the main cause is most likely one of two reasons:
 - i. The hardware was not sufficiently tightened during assembly. All bolts that were installed during assembly need to be tightened as much as possible. It may be necessary to use a larger wrench than the one provided if you cannot tighten the bolts sufficiently. I cannot stress this point enough; 90% of calls to the service department for noise issues can be traced to loose hardware or the rear rails being dirty.
 - ii. Dirt build-up on the rear rails and polyurethane wheels are also a source of noise. Noise from build-up on the rails can cause a thumping sound that you would swear is coming from inside the main body of the machine because noise travels, and is amplified, in the tubing of the frame. Clean the rails and wheels with a lint free cloth and rubbing alcohol. Stubborn build-up can be removed with your thumbnail or a non-metallic scraper, like the back edge of a plastic knife. After cleaning, apply a small amount of lubricant on the rails with your fingers or a lint free cloth. You only need a thin coat of lubrication, wipe off any excess.
3. If squeaks or other noises persist, check that the unit is properly leveled. There are 4 leveling pads on the bottom of the rear rails, use a 14mm wrench (or adjustable wrench) to adjust the levelers.

Maintenance Menu in console software:

The console has built in maintenance/diagnostic software. The software will allow you to change the console settings from English to Metric and turn off the beeping of the speaker when a key is pressed for example. To enter the Maintenance menu (may be called Engineering mode, depending on version) press and hold down the Start, Stop and Enter keys. Keep holding the keys down for about 5 seconds and the message window will display "ALTXXXX Engineering mode". Press the enter button to access the menu below:

- a. **Key test** (will allow you to test all the keys to make sure they are functioning)
- b. **Display test** (tests all the display functions)
- c. **Functions** (Press enter to access settings)
 - i. **Sleep mode** (Turn on to have the console power down automatically after 20 minutes of inactivity)
 - ii. **Safety** (On = workload set to level 20 on power-up)
 - iii. **Motor test** (Press enter to run the workload motor up and down in a continuous loop. Display shows level setting and position sensor reading. Press stop to end test.)
 - iv. **Beep** (Turn on or off the beep when a key is pressed)
 - v. **Units** (Set to English or Metric display readings)
 - vi. **ODO reset** (reset the odometer)
 - vii. **Pause Mode** (Turn on allow 5 minutes of pause, turn off to have the console pause indefinitely)
- d. **Security** (Allows you to lock the keypad so no unauthorized use is allowed)
- e. **Factory settings** (Access only allowed by manufacturing)
- f. **Exit**

Calibration: If the console shows an error for the incline/ramp, re-calibrating the system may resolve the problem. Press and hold the Start & work level UP keys for 5 seconds. The message window will show "Calibration"; press enter. The calibration process is automatic and the system will restart when finished.

Manufacturer's Limited Warranty

Effective September 15, 2008 Model EL 7 ELLIPTICAL WARRANTY

Spirit Manufacturing Inc. warrants all its elliptical parts for a period of time listed below, from the date of retail sale as determined by sale receipt, or in the absence of a receipt eighteen (18) months from the original factory shipping date. Spirit's responsibilities include providing new or remanufactured parts, at Spirit's option, and technical support to our independent dealers and servicing organizations. In the absence of a dealer or service organization these warranties will be administered by Spirit directly to a consumer. The warranty period applies to the following components:

Labor	1 Year
Frame and Brake	Lifetime
All Other Components	5 Years

NORMAL RESPONSIBILITIES OF THE CONSUMER

This warranty applies only to products in ordinary household use, and the consumer is responsible for the items listed below:

1. The warranty registration card must be completed and returned to the address listed on the card within 10 days of the original purchase to validate the manufacturer's limited warranty.
2. Proper use of the elliptical in accordance with the instructions provided in this manual
3. Proper installation by an authorized Spirit service company in accordance with instructions provided with the elliptical and with all local electric codes.
4. Proper connection to a grounded power supply of sufficient voltage, replacement of blown fuses, repair of loose connections or defects in house wiring.
5. Expenses for making the elliptical accessible for servicing, including any item that was not part of the elliptical at the time it was shipped from the factory.
6. Damages to the elliptical finish during shipping, installation or following installation. If the finish is damaged due to shipping, notify the shipping company and Spirit immediately.

EXCLUSIONS

This warranty does not cover the following:

1. CONSEQUENTIAL, COLLATERAL, OR INCIDENTAL DAMAGES SUCH AS PROPERTY DAMAGE AND INCIDENTAL EXPENSES RESULTING FROM ANY BREACH OF THIS WRITTEN OR ANY IMPLIED WARRANTY.

Note: Some states do not allow the exclusion or limitation of incidental or consequential damages, so this limitation or exclusion may not apply to you.

2. Service call reimbursement to the consumer. Service call reimbursement to the dealer that does not involve malfunction or defects in workmanship or material, for units that are beyond the warranty period, for units that are beyond the service call reimbursement period, for elliptical not requiring component replacement, or elliptical not in ordinary household use.
3. Damages caused by services performed by persons other than authorized Spirit service companies; use of parts other than original Spirit parts; or external causes such as alterations, modifications, abuse, misuse, accident, improper maintenance, inadequate power supply, or acts of God.
4. Products with original serial numbers that have been removed or altered.
5. Products that have been sold, transferred, bartered, or given to a third party.
6. Products that do not have a warranty registration card on file at Spirit Mfg. Spirit reserves the right to request proof of purchase if no warranty record exists for the product.
7. THIS WARRANTY IS EXPRESSLY IN LIEU OF ALL OTHER WARRANTIES EXPRESSED OR IMPLIED, INCLUDING THE WARRANTIES OF MERCHANTABILITY AND/OR FITNESS FOR A PARTICULAR PURPOSE.

SERVICE

Keep your bill of sale. Twelve (12) months from the date on the bill of sale or eighteen (18) months from the date of factory shipping as determined by the serial number establishes the labor warranty period should service be required. If service is performed, it is in your best interest to obtain and keep all receipts. This written warranty gives you specific legal rights. You may also have other rights that vary from state to state. Service under this warranty must be obtained by following these steps, in order:

1. Contact your selling authorized Spirit dealer. OR
2. Contact your local authorized Spirit service organization.
3. If there is a question as to where to obtain service, contact our service department at (870) 935-1107.
4. If no local service is available, Spirit will repair or replace the parts, at Spirit's option, within the warranty period at no charge for parts. All transportation costs, both to our factory and upon return to the owner, are the responsibility of the owner. The owner is responsible for adequate packaging upon return to Spirit. Spirit is not responsible for damages in shipping. Make all freight damage claims with the appropriate freight carrier. DO NOT SHIP ANY UNIT TO OUR FACTORY WITHOUT A RETURN AUTHORIZATION NUMBER. All units arriving without a return authorization number will be refused.
5. For any further information, or to contact our service department by mail, send your correspondence to:

Spirit Manufacturing, Inc.
P.O. Box 2037
Jonesboro, AR 72402-2037

Product features or specifications as described or illustrated are subject to change without notice. All warranties are made by Spirit Manufacturing, Inc. This warranty applies only in the 50 states of the U.S.A.